

FALL WINTER 2014 - 2015



tucanourbano.com

Tucano Urbano

Motorbike and scooter clothing and accessories

FALL
WINTER
2014 - 2015

Tucano Urbano Srl

Via 2 Giugno 60/b5

20068 Peschiera Borromeo (MI)

tel +39.02.55305203

fax +39.02.55301411

export@tucanourbano.com

www.tucanourbano.com

Legend

Description

Product code

















ERMES 8918MF029

Product Icons

N-black / DB-dark beige

Colours

6 sizes 46IT-S / 56IT-3XL

-  Waterproof
-  PVC Free
-  Water-Repellent
-  Breathable
-  Insulation
-  Windbreaker
-  Lady
-  12 months
-  Nano Collection
-  Real Leather
-  Hard Insert
-  Equipped for Airbag Use
-  CE Approved
-  CE Approved Gloves
-  Touchscreen Gloves
-  CE EN 1621-1/2:2011 D3O™ Armour
-  CE EN 1621-1:1997 Rigid Armour

Index

Legend	p. 3
About us	p. 4
Leg cover and hand grip covers	p. 5
Termoscud® leg covers	p. 6
Gaucho leg covers	p. 11
Termoscud® Passenger leg covers - Takeaway	p. 12
Polyamide hand grip covers	p. 13
Neoprene hand grip covers	p. 14
Clothing	p. 15
Man	p. 16
Lady	p. 26
Rainwear	p. 33
Rainwear	p. 34
Nano Collection	p. 39
Kid collection	p. 43
Gloves	p. 47
Gloves with protections	p. 48
Gloves without protections	p. 54
Accessories	p. 58
Thermal clothing accessories	p. 59
Accessories	p. 66
Bags	p. 71
Nano Bags	p. 74
Accessories	p. 76
Safety	p. 79
Helmet	p. 80
Airbag	p. 83
Armour	p. 84
Termoscud® Compatibility	p. 86
Product code index	p. 91

NOTE

Please note that due to printing reasons the orange colour may not be accurate. Please refer to the catalogue cover for accurate colours.

About us

Milan - the late '90s. Tired of struggling with the cold while getting around town on a scooter, we thought why not fix it? And so the **Termoscud**[®] leg cover was born. First just a few universal models and then increasingly specific designs for each scooter. Starting in Milan and then spreading to other big cities, to become 'the Tucano' or 'the Leg Cover' of choice: the one and only original leg cover for scooters, featuring the patented antiflap **S.G.A.S.** system.

Year by year, the Termoscud[®] has been joined by waterproofs, clothing, gloves, bags and a wide range of accessories addressing functionality, comfort and safety whilst always retaining that all-important Italian style. Designed to meet the needs of the urban traveller getting around at work and play. From home to work, from work to an evening out, for shopping and all the myriad daily chores: always protected in any weather and always ready for any event.



Leg cover and hand grip covers

Scooters are nippy in the city, fast, light, clean and trustworthy: that's the way it has to be in winter too. We can't be ruled by the weather and there's no time to waste putting on heavy gear, so the natural choice for the winter season is Termoscud®: the original leg cover.



TERMOSCUD® EVO

The original leg cover with new **PATENTED ANTI-FLAP INFLATABLE SYSTEM (S.G.A.S. 2.0)**: the inflatable chambers on the sides of the cover **prevent flapping at high speed**. This new improved version uses a **new material** and **valve to maintain pressure over long trips**.



N-black



NEW COLLECTION

- Three separate layers guarantee waterproofing and thermal insulation:
 - The exterior is Tarpaulin and heavy Polyamide, tough and waterproof, with taped seams
 - The inner membrane is 100% waterproof
 - The heavy quilt for winter can be removed in summer
- **S.G.A.S. 2.0**: the patented anti-flap inflatable system, with new control valve and high resistance material to ensure pressure is maintained over longer periods
- **Fitting System**: the Termoscud® EVO can be adapted to the legs and different body sizes by varying the inflation of the S.G.A.S. 2.0 air chambers
- **Safety Release**: safety system for releasing the lower straps allowing the feet to move in cases of loss of balance
- Non-scratch neoprene inserts to improve Termoscud® adherence to bodywork and prevent chafing
- Antitheft ring
- Large pocket for baggage
- Seat cover stored in bib
- Reflective edging and details

Optional accessories and spare parts:

Cod. R315EV-1
Right low inflatable

Cod. R315EV-2
Left low inflatable

Cod. R315EV-3
Universal high inflatable

Cod. R316EV
Removable heavy quilt



Custom models for specific scooters
(for compatibility lists see pages 86-89 and
our website www.TucanoUrbano.com).

Can be fitted without a mechanic or specialist.

Cleaning instructions: use a damp cloth,
rinse and dry the tapes well before storing
in a dry place.



Termoscud® leg covers

TERMOSCUD® evo

- 1 Heavy quilt for winter, removable
- 2 Fitting System valve; reflective edging and details
- 3 Aero 3D mesh
- 4 Safety Release: safety system for releasing the lower straps
- 5 S.G.A.S. 2.0 valve

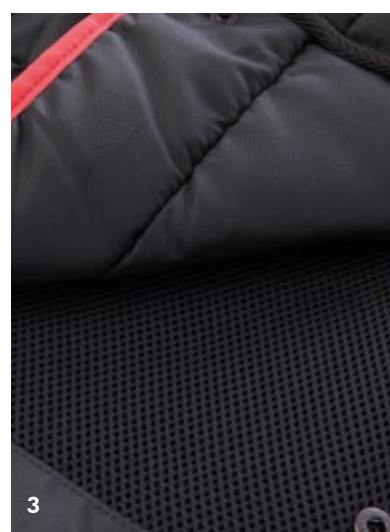

THERMAL CONTROL SYSTEM

- in the closed position the deflector directs the warm radiator air to the Termoscud® EVO
- in the open position the deflector prevents the entry of cold air (cold engine) to the Termoscud® EVO
- easy to use
- patented system
- **available only on models R154EV / R173EV**



PATENTED SYSTEM

TERMOSCUD®

The original leg cover with **PATENTED ANTI-FLAP INFLATABLE SYSTEM (S.G.A.S.)**: the inflatable chambers on the sides of the cover prevent flapping at high speed.



N-black



- Three-layer construction to ensure thermal protection and waterproofing:
 - Waterproof heavy Polyamide outer shell and taped seams
 - Fully waterproof inner membrane
 - Lined interior for extra warmth
- S.G.A.S. anti-flap inflatable system
- Anti-theft system (metal ring) available for models not requiring screw fixing
- Large storage pocket
- Built-in saddle cover
- Reflective edging



R078

Custom models for specific scooters (for compatibility lists see pages 86-89 and our website www.TucanoUrbano.com).

Can be fitted without a mechanic or specialist.

Recommended cleaning: use a damp cloth, rinse thoroughly and then dry all straps before storing in a dry place.

S.G.A.S. ANTI-FLAP INFLATABLE SYSTEM

All Termoscud® leg covers are equipped with a patented system that consists of inflatable chambers on the sides of the cover that prevents flapping at high speeds.



Do not inflate using a compressor or pump Pressure not to exceed 0.1Bar / 1.3PSI

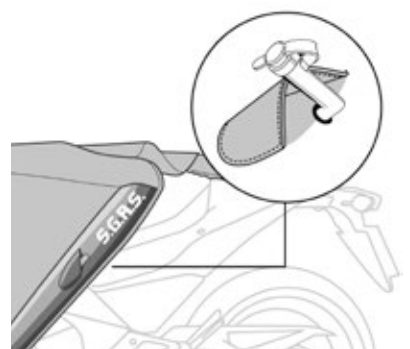

Termoscud® leg covers

THERMAL CONTROL SYSTEM

- When closed, the two side deflectors trap hot air inside the leg cover
- When open, the hot air is allowed to escape
- Very fast to use
- Patented system
- **Available only on R049, R079, R154, R156, R161 Termoscud® leg covers**



PATENTED SYSTEM

- 1 Built-in saddle cover
- 2 Positioning for strap 5
- 3 Large glove pocket
- 4 Anti-theft system (metal ring) available only on the models without screws
- 5 Replacing strap 2 and buckle
- 6 Rubber washer
- 7 Termoscud® folded
- 8 Reflective strip for personalisation with registration number



R062



Termoscud® leg covers

R166



R096



R089



R084



R097



R099



R081



R163



R090



R154



R162



R095



GaUCHO leg covers

GAUCHO R117 / R118 / R119 / R120*



N-black



- Waterproof outer shell made from heavy Polyamide
- Lined interior for extra warmth
- Padded heat resistant reinforcements
- Anti-theft system (metal ring)
- S.G.A.S. anti-flap inflatable system

*Specific for BMW R1200GS



R120

S.G.A.S. ANTI-FLAP INFLATABLE SYSTEM

All GaUCHO leg covers are equipped with a patented system that consists of inflatable chambers on the sides of the cover that prevents flapping at high speeds.



PATENTED SYSTEM



R117



R118



R119



R119

Termoscud® Passenger leg covers - Takeaway

TERMOSCUD® PASSENGER R091

Fastened directly to the existing Termoscud®

TERMOSCUD® PASSENGER R092

Fastened directly to the pilot's waist



N-black



- Waterproof outer shell made from heavy Polyamide
- Lined interior for extra warmth
- Patented design
- Reflective safety band



R092



R091



R092

TAKEAWAY R093



N-black



4 sizes S / XL

- Universal thermal leg cover
- Totally independent. Does not fix to vehicle
- Specifically designed to allow maximum freedom of movement, versatility and safety
- Maximum guarantee of safety
- Ergonomic cut eliminating the risk of flapping at higher speeds
- Much easier to put on than conventional over trousers
- Fully waterproof Polyester
- High grade thermal lining for extra warmth
- Taped seams - Easily compactable for ease of storage
- Patent pending



PATENT PENDING



POLYAMIDE HAND GRIP COVERS R333

NEW COLLECTION

Universal hand grip covers for handlebars with or without end weights



N-black



- New design for universal application
- Heavy Polyamide waterproof outer covering
- Added interior
- Patented mounting system
- Screw tight safety closure
- Transparent window to see displays
- Reflective strips
- Reinforcement on front



HEATED POLYAMIDE HAND GRIP COVERS R333EV

NEW COLLECTION

Universal hand grip covers for handlebars with or without end weights



N-black



- New design for universal application
- Heavy Tarpaulin and Polyamide waterproof outer covering
- Heated interior
- Heat adjustable to 4 levels
- Cable connecting heating element to battery, with safety fuse
- Patented mounting system
- Screw tight safety closure
- Electronic anti-theft with key ring
- Transparent window to see displays
- Reflective strips
- Reinforcement on front



NEOPRENE HAND GRIP COVERS R365



1-black

- Model specifically designed for Honda Integra
- Universal model for handlebars with bar end weights
- Neoprene with thermal padding
- Rigid opening with synthetic fur trim
- Anti-theft fixing system



NEOPRENE HAND GRIP COVERS R360

Universal model for handlebars without bar end weights



1-black

- Universal model for handlebars without bar end weights
- Neoprene with thermal padding
- Rigid opening with synthetic fur trim
- Anti-theft fixing system
- Patented system

PATENTED SYSTEM



NEOPRENE HAND GRIP COVERS R361

Universal model for handlebars with bar end weights



1-black

- Universal model for handlebars with bar end weights
- Neoprene with thermal padding
- Rigid opening with synthetic fur trim
- Hard insert for high speed performances
- Anti-theft fixing system
- Patented system



Clothing



In our waterproof garments, the **waterproofing is 100% guaranteed** by an inner membrane or the use of coated fabrics and taped seams.

All waterproof garments have the ability to withstand the pressure of a high water column, according to European Standard UNI EN 20811.



PVC waterproofing has been eliminated in all Tucano Urbano gloves and clothing. **A choice for the environment and your health.**



On the other hand, **water repellent** fabric causes water to run off, without being absorbed by the fibres. The duration of treatment will vary with the repellent used.

TUCANO URBANO PRODUCTS BENEFIT FROM THREE REGISTERED DESIGN SYSTEMS:



To guarantee total waterproofing and breathability, a 100% rain seal is provided by an inner membrane or the use of coated fabrics and taped seams.



To guarantee absolute functionality and comfort, each pocket is specifically designed to keep everything in its place, so you can easily find it when you need it.



For complete safety and style, reflective inserts are cleverly concealed: you can reveal them when riding and conceal them once you arrive at your destination.



ERMES 8918MF029



N-black / DB-dark beige



6 sizes 46IT-S / 56IT-3XL

- ¾ length touring jacket **Black Label**
- CE approved D3O™ Level 2 (code 8003) elbow and (code 8005) shoulder armour provided
- Ability to insert CE D3O™ back armour
- HYDROSCUD®:
 - Breathable, windproof and waterproof outer shell made from Oxford Polyamide
 - Taped seams
- Abrasion resistant fabric
- 3D Polyester mesh lining
- Removable Polyester thermal padding
- REFLECTIVE® SYSTEM – Visibility on demand
- Removable internal brace for carrying cross shoulder
- Helmet loop
- Removable lumbar support
- Adjustable wrist strap with buttons and zip
- Width adjustment system on arms and sides
- Ventilation system on undersleeve, chest, side and back
- FIND IT EASY® – Everything in the right place



GIACCA TRIP AB 8855



N-black / DB-dark beige



6 sizes S / 3XL

- Touring jacket suitable for all year round use
- Breathable and waterproof outer shell made from Oxford Polyamide fabric
- Synthetic down removable inner jacket
- Taped seams
- Ability to insert CE D3O™ elbow and shoulder armour
- Equipped for Airbag use
- Reflective band on the collar
- Ventilation system for the chest, sides and back
- Ergonomic hood, folds into the collar
- Internal and external pockets in various sizes



Synthetic down removable inner jacket

URBIS 4G 8910MF022



N-black



7 sizes 46IT-S / 58IT-4XL

MA-brown / B-blue



6 sizes 46IT-S / 56IT-3XL

- Medium cut padded jacket
- HYDROSCUD®:
 - Breathable, windproof and waterproof outer shell made from Oxford Polyamide
 - Taped seams
- "Aero 3D" thermostatic lining
- Thermal padding made from Polyester
- Detachable inner waistcoat in windbreaker fleece (can be worn as separate garment)
- Ability to insert CE D3O™ elbow, shoulder and back armour
- REFLECTIVE® SYSTEM – Visibility on demand
- Elastic windproof cuffs
- FIND IT EASY® – Everything in the right place



Detachable inner waistcoat in windbreaker fleece (can be worn as separate garment)

Combo with Panta Urbis T page 24

4TEMPI 8935MF040

NEW COLLECTION



N-black / GR-grey



6 sizes 46IT-S / 56IT-3XL

- Four seasons medium length jacket
- HYDROSCUD®:
 - breathable Polyamide exterior, windproof and high waterproof rating
 - Taped seams
- Polyester lining
- Detachable quilted lining with Polyester thermal padding
- CE approved D3O™ Level 1 (code 8002) elbow armour provided
- Ability to insert CE D3O™ shoulder and back armour
- REFLECTIVE® SYSTEM – Visibility on demand
- Elasticated windproof wrist cuffs
- Ergonomic adjustable and detachable hood
- Adjustable waist
- Elbow patches



PIUMATICO 8943MF57

NEW COLLECTION



N-black



5 sizes 46IT-S / 54IT-XXL

- Seamless Welded Jacket
- HYDROSCUD®:
 - Breathable Polyamide/Polyester exterior, windproof and high waterproof rating
 - Taped seams
- Wool-touch fabric
- Polyester lining
- Polyester injected-flock thermal lining
- Ability to insert CE D3O™ elbow, shoulder and back armour
- REFLECTIVE® SYSTEM – Visibility on demand
- Adjustable and detachable hood-collar



PARK 8937MF022



N-black



6 sizes 46IT-S / 56IT-3XL

- Medium length parka jacket
- HYDROSCUD®:
 - Breathable Oxford Polyamide exterior, windproof and high waterproof rating
 - Taped seams
- Polyester lining
- Polyester thermal padding
- CE approved D3O™ Level 1 (code 8002) elbow protectors provided
- Ability to insert CE D3O™ shoulder and back armour
- REFLECTIVE® SYSTEM – Visibility on demand
- Elasticated windproof wrist cuffs
- Ergonomic adjustable and detachable hood
- Adjustable waist
- FIND IT EASY® – Everything in the right place
- Elbow patches



MOD 8909MF017



N-black / VE-green



6 sizes 46IT-S / 56IT-3XL

- ¾ length parka
- HYDROSCUD®:
 - Breathable, windproof and waterproof outer shell made from Polyamide
 - Taped seams
- Polyester lining
- Thermal padding made from Polyester
- Detachable inner made from sheepskin effect fleece
- Ability to insert CE D3O™ elbow, shoulder and back armour
- REFLECTIVE® SYSTEM – Visibility on demand
- Elastic windproof cuffs
- Ergonomic adjustable hood
- Adjustable waist
- FIND IT EASY® – Everything in the right place
- Handwarmer pockets for passengers on the sides



FICUS 8907MF021



N-black / B-blue



6 sizes 46IT-S / 56IT-3XL

- Long cut padded coat
- HYDROSCUD®
- Breathable, windproof and waterproof outer shell made from Oxford Polyamide
- Taped seams
- Polyester lining
- Thermal padding made from Polyester
- Detachable inner waistcoat made from Polyamide, thermal padding made from Polyester (can be worn as separate garment)
- Ability to insert CE D30™ elbow, shoulder and back armour
- REFLECTIVE® SYSTEM – Visibility on demand
- Elastic windproof cuffs
- FIND IT EASY® – Everything in the right place



Detachable inner waistcoat made from Polyamide, thermal padding made from Polyester (can be worn as separate garment)

BENJAMIN 8906MF021



N-black / B-blue



6 sizes 46IT-S / 56IT-3XL

- ¾ length padded jacket
- HYDROSCUD®:
 - Breathable, windproof and waterproof outer shell made from Oxford Polyamide
 - Taped seams
- Polyester lining
- Thermal padding made from Polyester (can be worn as separate garment)
- Ability to insert CE D30™ elbow, shoulder and back armour
- REFLECTIVE® SYSTEM – Visibility on demand
- Elastic windproof cuffs
- Removable ergonomic hood, folds into a special internal pocket
- FIND IT EASY® – Everything in the right place



Thermal padding made from Polyester (can be worn as separate garment)

CARTER 8938MF038



N-black / RS-dark red



6 sizes 46IT-S / 56IT-3XL

- Short jacket
- HYDROSCUD®:
 - Breathable Polyamide exterior, windproof and high waterproof rating
 - Taped seams
- Polyester lining
- Detachable quilted lining with Polyester thermal padding
- CE approved D3O™ Level 1 (code 8002) elbow armour provided
- Ability to insert CE D3O™ shoulder and back armour
- REFLECTIVE® SYSTEM – Visibility on demand
- Elasticated windproof wrist cuffs
- FIND IT EASY® – Everything in the right place
- Elbow patches

NEW COLLECTION



2CILINDRI 8939MF039



N-black / FA-mud / GR-grey



6 sizes 46IT-S / 56IT-3XL

- Short jacket
- HYDROSCUD®:
 - Breathable Polyamide exterior, windproof and high waterproof rating
 - Taped seams
- Herringbone weave fabric
- Polyester lining
- Polyester thermal padding
- CE approved D3O™ Level 1 (code 8002) elbow armour provided
- Ability to insert CE D3O™ shoulder and back armour
- REFLECTIVE® SYSTEM – Visibility on demand
- Elasticated windproof wrist cuffs
- Adjustable waist
- FIND IT EASY® – Everything in the right place
- Elbow patches

NEW COLLECTION



PIGNONE 898MF042

NEW COLLECTION



BS-dark blue / GR-grey



7 sizes 44IT-XS / 56IT-3XL

- Classic cut windproof and water-repellent blazer
- Breathable Polyester outer and lining
- Ultra-light thermal padding
- Ability to insert CE D30™ elbow and back armour
- REFLECTIVE® SYSTEM – Visibility On Demand
- Detachable windproof apron



LOW DOG 8889



N-black / BB-light blue



6 sizes S / 3XL

- Extra light down jacket, can be worn as an insulating layer or a separate jacket
- Water-repellent outer shell made from Polyamide
- Polyamide lining
- Extra light synthetic down thermal padding
- Total wind protection
- Internal and external pockets in various sizes



HOT FAB 8891



N-black / BB-light blue



6 sizes S / 3XL

- Windproof and water-repellent men's padded gilet
- Extra light synthetic down thermal padding
- Reflective logo
- 2 outer pockets, 2 inside pockets



RUDY 8911MF023



B-blue / GS-dark grey / N-black



6 sizes 46IT-S / 56IT-3XL

- Short cut quilted padded jacket
- Breathable, windproof and water-repellent outer shell in Polyamide
- Sheepskin effect fleece lining
- Thermal padding made from Polyester
- Reflective logo
- Internal and external pockets in various sizes



GOMEZ 8912MF024



N-black / B-blue / MA-brown / VS-dark green



7 sizes 44IT-XS / 56IT-3XL

- Short cut padded jacket
- Breathable, windproof and water-repellent outer shell in Polyamide
- Polyester lining
- Thermal padding made from Polyester
- Reflective logo
- Internal and external pockets in various sizes



PANTA URBIS T 831T



N-black



7 sizes XS / 3XL

- Waterproof and breathable outer shell in Polyamide Oxford
- Detachable padded lining
- Taped seams
- Reflective safety band
- Side zip fastener, that opens right to the beltline, with water protective flap
- Ability to insert CE D3OTM knee armour



Combo with
Urbis 4G
page 17



K-GINS 8927MF031



N-black / B-blue



6 sizes S / 3XL

- Denim trousers made from 100% Cotton with water-repellent treatment
- REFLECTIVE® SYSTEM – Visibility on demand
- Ability to insert D3O™ CE knee and hip armour with aramid fiber (Kevlar®) inserts
- 5 pockets
- Regular fit

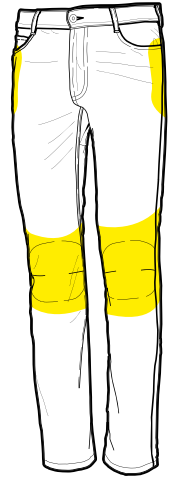

GINs 8926MF031



N-black / B-blue



6 sizes S / 3XL

- Denim trousers made from 100% Cotton with water-repellent treatment
- REFLECTIVE® SYSTEM – Visibility on demand
- Ability to insert D3O™ CE knee and hip armour
- 5 pockets
- Regular fit



IRIS 8919WF029



N-black



6 sizes 38IT-XS / 48IT-XXL

- Women's ¾ length touring jacket Black Label
- CE approved D3O™ Level 2 (code 8003) elbow and (code 8005) shoulder armour provided
- Ability to insert CE D3O™ back armour
- HYDROSCUD®:
 - Breathable, windproof and waterproof
 - outer shell made from Oxford Polyamide
 - Taped seams
- Abrasion resistant fabric
- 3D Polyester mesh lining
- Removable polyester thermal padding
- REFLECTIVE® SYSTEM – Visibility on demand
- Removable internal brace for carrying cross shoulder
- Helmet loop
- Removable lumbar support
- Adjustable wrist strap with buttons and zip
- Width adjustment system on arms and sides
- Ventilation system on undersleeve, chest, side and back
- FIND IT EASY® – Everything in the right place



4TEMPI LADY 8936WF040



N-black / GR-grey



7 sizes 38IT-XS / 50IT-3XL

- Four seasons medium length jacket
- HYDROSCUD®:
 - breathable Polyamide exterior, windproof and high waterproof rating
 - Taped seams
- Polyester lining
- Women's cut
- Detachable quilted lining with Polyester thermal padding
- CE approved D3O™ Level 1 (code 8002) elbow protectors provided
- Ability to insert CE D3O™ shoulder and back armour
- REFLECTIVE® SYSTEM – Visibility on demand
- Elasticated windproof wrist cuffs
- Ergonomic adjustable and detachable hood
- Adjustable waist
- Elbow patches



NEW COLLECTION

CANDELA 8942WF039



N-black



7 sizes 38IT-XS / 50IT-3XL

GR-grey / RS-dark red



6 sizes 38IT-XS / 48IT-XXL

- 3/4 length parka jacket
- Hydroscud®:
 - Breathable Polyamide exterior, windproof and high waterproof rating
 - Taped seams
- Herringbone weave fabric
- Polyester lining
- Women's cut
- Polyester thermal padding
- CE approved D3O™ Level 1 (code 8002) elbow armour provided
- Ability to insert CE D3O™ shoulder and back armour
- REFLECTIVE® SYSTEM – Visibility on demand
- Elasticated windproof wrist cuffs
- Ergonomic adjustable and detachable hood
- Adjustable waist
- FIND IT EASY® – Everything in the right place
- Elbow patches



MODETTE 8913WF002



N-black / VE-green



7 sizes 38IT-XS / 50IT-3XL

- ¾ length padded women's parka
- HYDROSCUD®:
 - Breathable, windproof and waterproof outer shell made from Polyester microfibre/Polyamide
 - Taped seams
- Polyester lining
- Thermal padding made from Polyester
- Detachable inner made from sheepskin effect fleece
- Ability to insert CE D3O™ elbow, shoulder and back armour
- REFLECTIVE® SYSTEM – Visibility on demand
- Elastic windproof cuffs
- Ergonomic adjustable hood
- Adjustable waist
- FIND IT EASY® – Everything in the right place
- Handwarmer pockets for passengers on the sides



BRIGITTE BARBET 8908WF021



N-black / MS-dark brown / B-blue



7 sizes 38IT-XS / 50IT-3XL

- ¾ length women's padded jacket
- HYDROSCUD®:
- Breathable, windproof and waterproof outer shell made from Oxford Polyamide
- Taped seams
- Polyester lining
- Quilted thermal padding made from Polyester
- Ability to insert CE D3O™ elbow and shoulder armour
- REFLECTIVE® SYSTEM – Visibility on demand
- Elastic windproof cuffs
- Removable ergonomic adjustable hood
- FIND IT EASY® – Everything in the right place



SERISSA 8914WF002



N-black / B-blue



7 sizes 38IT-XS / 50IT-3XL

- Women's ¾ length padded double-breasted trench coat
- HYDROSCUD®:
- Breathable, windproof and waterproof outer shell made from Polyester/Polyamide microfibre
- Taped seams
- Polyester lining
- Thermal padding made from Polyester
- Inner padded jacket made from Polyester (can be worn as separate garment)
- Ability to insert CE D3O™ elbow, shoulder and back armour
- REFLECTIVE® SYSTEM – Visibility on demand
- Elastic windproof cuffs
- FIND IT EASY® – Everything in the right place



Inner padded jacket made from Polyester (can be worn as separate garment)

BICILINDRICA 8944WF039

NEW COLLECTION



N-black / GR-grey / RS-dark red



6 sizes 38IT-XS / 48IT-XXL

- Short jacket
- HYDROSCUD®:
 - Breathable Polyamide exterior, windproof and high waterproof rating
 - Taped seams
- Herringbone weave fabric
- Polyester lining
- Women's cut
- Polyester thermal padding
- CE approved D3O™ Level 1 (code 8002) elbow protectors provided
- Ability to insert CE D3O™ shoulder and back armour
- REFLECTIVE® SYSTEM – Visibility on demand
- Elasticated windproof wrist cuffs
- Adjustable waist
- FIND IT EASY® – Everything in the right place
- Elbow patches

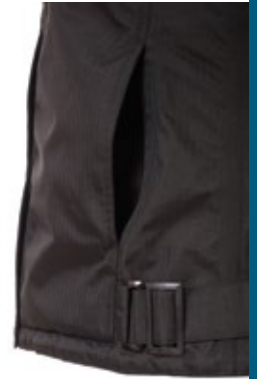

FRECCIA 899WF042

NEW COLLECTION



BS-dark blue / GR-grey / R-red



7 sizes 36IT-XXS / 48IT-XXL

- Classic cut windproof and water-repellent blazer
- Breathable Polyester outer and lining
- Women's cut
- Ultra-light thermal padding
- Ability to insert CE D3O™ elbow and back armour
- REFLECTIVE® SYSTEM – Visibility On Demand
- Detachable windproof apron



LAURA 8888



N-black / B-blue / GR-grey



6 sizes 38 / 48

- Women's extra light $\frac{3}{4}$ length down jacket
- Water-repellent outer shell made from Polyamide
- Polyamide lining
- Extra light synthetic down thermal padding
- Reflective logo
- Removable ergonomic hood
- Total wind protection
- Internal and external pockets in various sizes



BIELLA 8945WF53



B-blue / GR-grey / R-red



6 sizes 38IT-XS / 48IT-XXL

- Quilted water-repellent, windproof and breathable jacket
- Polyester lining and shell
- Women's cut
- Ultra-light Polyester thermal padding

NEW COLLECTION



LOW DAN 8890



N-black / OT-teal



6 sizes 38 / 48

- Women's extra light down jacket, can be worn as an insulating layer or a separate jacket
- Water-repellent outer shell made from Polyamide
- Polyamide lining
- Extra light synthetic down thermal padding
- Total wind protection
- Internal and external pockets in various sizes



HOT DAN 8892



N-black / OC-ochre / OT-teal



6 sizes 38 / 48

- Windproof and water-repellent women's padded gilet
- Extra light synthetic down thermal padding
- Reflective logo
- 2 outer pockets, 2 inside pockets



TRUDY 8915WF023



N-black / B-blue / GB-greige / GS-dark grey



6 sizes 38IT-XS / 48IT-XXL

- Women's short cut quilted padded jacket
- Breathable, windproof and water-repellent outer shell in Polyamide
- Sheepskin effect fleece lining
- Thermal padding made from Polyester
- Reflective logo
- Internal and external pockets in various sizes



MERCOLEDI 8916WF024



N-black / MA-brown



8 sizes 36IT-XXS / 50IT-3XL

GH-ice / OC-ochre



7 sizes 36IT-XXS / 48IT-XXL

BB-light blue / R-red / B-blue / VS-dark green



8 sizes 34IT-3XS / 48IT-XXL

- Women's short cut padded jacket
- Breathable, windproof and water-repellent outer shell in Polyamide
- Polyester lining
- Thermal padding made from Polyester
- Reflective logo
- Internal and external pockets in various sizes



Rainwear



PVC waterproofing has been eliminated in all Tucano Urbano gloves and clothing. **A choice for the environment and your health.**



This icon denotes products which retain their technical abilities whilst being **extremely compactable** through the use of super lightweight fabrics and specially crafted finishes.



PARABELLUM 516



N-black



4 sizes XS-S / M-L / XL-XXL / 3XL-4XL

- Calf length fully waterproof jacket
- Lightweight PU coated waterproof Polyamide
- Taped seams
- Reflective band
- Ergonomic hood, folds into the collar
- Full-length front opening
- "Anti-flap" adjustable ankle straps
- Adjustable waist
- Inner pocket access
- Compact



PARABELLA 560



N-black



4 sizes XS / L

- Ladies calf-length trench coat
- Fully waterproof outer shell made from Polyamide
- Taped seams
- Reflective band on the collar
- Full-length front opening
- "Anti-flap" adjustable ankle straps
- Adjustable waist
- 2 external pockets
- Compact



NOÈ DILUVIO SET 563



GS-dark grey



9 sizes XXS /4XL

- Jacket and pants
- Lightweight Polyamide outer, windproof and high waterproof rating
- Taped seams
- Contrasting fluorescent strips
- Jacket lining in Polyester mesh
- Reflective inserts
- Pants side zippers can be opened up to the calf
- Ergonomic hood folds into collar
- Supplied in double sided bag for easy carrying and storage



LIGHT DILUVIO SET 534



N-black



9 sizes XXS / 4XL

- Fully waterproof lightweight Polyamide jacket and trousers
- Lining only in jacket
- Taped seams
- Reflective band
- Ergonomic hood, folds into the neck
- Side zip opening to the calf
- Supplied in double sided bag for easy carrying and storage



DILUVIO JACKET 537



N-black



6 sizes XS / XXL

- Men cut rain jacket
- Fully waterproof Polyester
- Inner lining
- Taped seams
- Reflective band
- Ergonomic hood, folds into the collar
- Adjustable waist belt



PANTA DILUVIO LIGHT 524



N-black



8 sizes XXS / 3XL

- Trousers in lightweight Polyamide
- Taped seams
- Reflective band
- Adjustable ankle straps
- Side zip opening to the calf
- Compact



DILUVIO TROUSERS 535



N-black



8 sizes XS / 4XL

- Fully waterproof Polyester
- Inner lining
- Taped seams
- Reflective band
- Side zip fastener, that opens right to the beltline, with water protective flap
- Adjustable ankle straps



PADDED DILUVIO TROUSERS 536



N-black



6 sizes XS / XXL

- Fully waterproof Polyester
- Thermal lining
- Taped seams
- Side zip fastener, that opens right to the beltline, with water protective flap
- Reflective band
- Adjustable ankle straps



SHOE COVER WITH SIDE ZIP 520E



N-black



6 sizes 38/39 40/41 42/43 44/45 46/47 48/49
To fit shoe 36/37 38/39 40/41 42/43 44/45 46/47

- 210/420 grade coated Polyamide
- Side zip with waterproof "trap"
- Taped seams
- Rubber soles
- Adjustable ankle straps
- Reinforced strip for gear changing on the left foot



PONCIARELLO 561



T-titanium / RD-rainy day



2 sizes S / L

- Compactable bicycle poncho
- Fully waterproof Polyamide outer shell
- Taped seams
- Silver interior
- Ergonomic hood, can also be worn over a helmet
- Transparent visor for side visibility
- Transparent porthole for better riding visibility
- Reflective side bands
- Hanger loop for rear light
- 2 chest pockets
- Elasticated anti-flap thumb-loops
- Convenient storage sack with reflective bands, can be attached to the bicycle

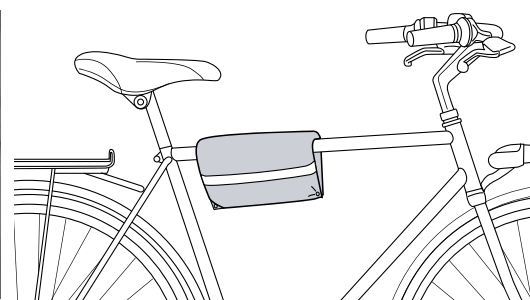

NANO RAIN JACKET 760



N-black



7 sizes S / 4XL

- Raincoat, fully waterproof and breathable, super-compact
- Polyamide outer shell
- Taped seams
- Reflective band on the collar
- Adjustable hem
- Convenient storage sack



180 gr ~

NANO RAIN LADY JACKET 761



N-black



5 sizes 38 / 46

- Women's raincoat, fully waterproof and breathable, super-compact
- Polyamide outer shell
- Taped seams
- Reflective band on the collar
- Adjustable hem
- Convenient storage sack



170 gr ~

NANO BULLET 762



N-black / YF-fluorescent yellow



7 sizes S / 4XL

BS-dark blue / PA-paprika / VE-green



6 sizes S / 3XL

- Super-compact, fully waterproof and breathable raincoat
- Outer shell made from Polyamide
- Taped seams
- Reflective bands on the collar and on the cuff
- Ergonomic hood, folds into the collar
- Drawstring hem
- 2 external pockets: 1 transforms into a compact pouch



250 gr ~

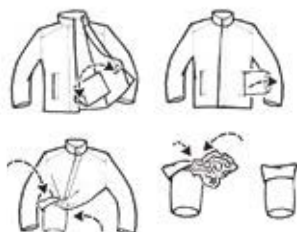

NANO LADY BULLET 763



N-black / BS-dark blue / LI-lilac / YF-fluorescent yellow /
PF-fluorescent pink / BH-hawaii blue / O-orange



5 sizes 38 / 46

- Super-compact, fully waterproof and breathable women's raincoat
- Outer shell made from Polyamide
- Taped seams
- Reflective bands on the collar and on the cuff
- Ergonomic hood, folds into the collar
- Drawstring hem
- 2 external pockets: 1 transforms into a compact pouch



250 gr ~

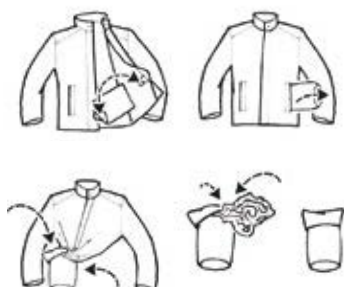

GILET NANO REFLEX 751



YF-fluorescent yellow



6 sizes S / 3XL

- High visibility super-compact windbreaker waistcoat
- Fully water-repellent and breathable outer shell made from Polyamide
- Light mesh Polyester lining
- Large reflective band
- Elastic inserts on waist and armhole
- 2 external pockets: 1 transforms into a compact pouch

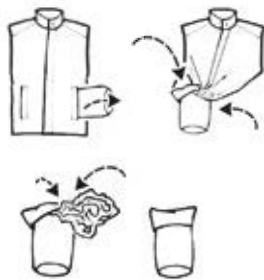

160 gr ~

NANO TROUSERS 733



N-black



7 sizes XS / 3XL

- Fully waterproof and breathable rain trousers
- Super-compact
- Outer Shell in Polyamide
- Taped seams
- Reflective band
- Adjustable ankle straps with lateral zip fastening
- Side zip opening to the calf
- Convenient storage sack



170 gr ~

TUTA NANO 730



N-black



7 sizes XS / 3XL

- Fully waterproof and breathable one piece suit, super-compact
- Outer shell in Polyamide
- Taped seams
- Reflective band
- Adjustable ankle strap with lateral zip fastening
- Side zip opening to the calf
- Convenient storage sack



 335 gr ~

NANO SHOE COVER WITH ZIP 718



N-black



6 sizes, for shoes sizes
36/37 38/39 40/41 42/43 44/45 46/47

- Super-compact fully waterproof shoe cover
- Outer shell in Polyamide
- Rear zip fastening with waterproof flap
- Taped seams
- Reflective band
- Flexible rubber sole
- Reinforced strip for gear changing on the left foot
- Supplied in a small storage pouch



 350 gr ~



Kid collection

Moms and dads:

if you appreciate what it means to whizz from one end of the city to the other in no time at all to pick up your kids from school or drop them off at a party, then you won't want to be without your wheels. Tucano Urbano has you and moreover them in mind with their new kid line, so that you can move around even on the coldest and wettest days without risking a sore throat.



MONTGOMERY KID 870K



B-blue



4 sizes 4-6-8-10

- Duffle coat suitable for motorbike and scooter use
- Breathable and waterproof Polyester/Viscose shell fabric
- Lining and thermal padding made from Polyester
- Taped seams
- Removable ergonomic hood
- Windproof cuffs
- Internal and external pockets in various sizes



WSP KID 8833K



MA-brown / BS-dark blue



5 sizes 4-6-8-10-12 years

- Short jacket suitable for all year round use
- Outer shell made from Polyester/Polyamide
- Fully waterproof and breathable membrane
- Fleece lining
- Removable ergonomic hood
- 2 outer pockets, 2 inside pockets



URBANJI KID 832K



R-red / BS-dark blue / GL-wisteria



5 sizes 4-6-8-10-12 years

- Kid padded gilet
- Windproof and breathable outer shell made from Polyester
- Polyester inner lining
- Extra light Polyester thermal padding
- Removable ergonomic hood, folds into the collar
- 4 outer pockets, 1 inside pocket
- Compact



NANO RAIN JACKET KID 760K



N-black / R-red



5 sizes 4-6-8-10-12 years

- Fully waterproof and breathable raincoat, super-compact
- Outer shell in Polyamide
- Taped seams
- Reflective band
- Removable ergonomic hood, folds into the collar
- Adjustable hem
- Convenient storage sack



NORTH POLE KID 670K



GP-slate grey



3 sizes 8-10-12 years

- Long sleeved thermal vest
- Elasticated Polyester
- Ideal as an undergarment



SOUTH POLE KID 671K



GP-slate grey



3 sizes 8-10-12 years

- Thermal under trousers
- Elasticated Polyester
- Ideal as an undergarment



Gloves

All the gloves in the Tucano Urbano collection are tested one by one.

Useful information

When choosing your gloves you should think about what you need in terms of heat insulation and sensitivity in your hands: a bulkier glove will offer better protection against the cold while a slimmer glove will offer you greater sensitivity when riding.

In the case of leather gloves you should choose a fairly tight-fitting size as the leather will adapt to your hands with use. Finally, always try on different sizes to find the right one for the characteristics you want!



NEW COLLECTION

HOT ROAD 9932U



N-black

6 sizes XS / XXL

- Heated gloves with two power supply options:
 1. 7.4V lithium batteries (4 pieces) (optional kit – **code 9932UBAT**)
 2. electrical power line fed by the bike's battery, with safety fuse (optional kit – **code 9932UCABLE**)
- On/off button, with choice of 4 heating levels
- Real leather palm
- Top side in leather/extra strong Oxford Polyamide
- Microfibre lining
- HYDROSCUD®: 100% waterproof and breathable inner membrane
- Hard ABS inserts on knuckles
- Reflective inserts
- Long wrist
- Anti-slip velcro fastening on cuff
- Draftproof inner cuff
- Visor wiping insert
- Touchscreen gloves
- Meets the CE prEN13594:2012 safety standards for motorbike gloves



NEW COLLECTION

ROAD 9925U



N-black

6 sizes XS / XXL

- Real leather palm
- Top side in leather/extra strong Oxford Polyamide
- Microfibre lining
- Thinsulate™ thermal filling
- HYDROSCUD®: 100% waterproof and breathable inner membrane
- Hard ABS inserts on knuckles
- Soft D3O insert on the palm
- Reflective inserts
- Long wrist
- Anti-slip velcro fastening on cuff
- Draftproof inner cuff
- Visor wiping insert
- Touchscreen gloves
- Meets the CE prEN13594:2012 safety standards for motorbike gloves



FIREWALL 9915U



N-black
6 sizes XS / XXL

- Outer shell in stretch Polyester
- Leather palm
- Thermolite® thermal padding
- Fully waterproof and breathable membrane
- Hard ABS inserts on knuckles
- Reflective bands
- Adjustable velcro wrist strap
- Anti-draught inner cuff
- Visor wiper
- Touchscreen gloves
- Meets the CE prEN13594:2012 safety standards for motorbike gloves



FLAMING 9917M



YF-fluo yellow
5 sizes S / XXL

- Outer shell in elastic fabric
- Thermolite® thermal padding
- Fully waterproof and breathable membrane
- Hard ABS inserts on knuckles
- Anti-slip inserts on the palm
- Reflective bands
- Adjustable velcro wrist strap
- Anti-draught inner cuff
- Visor wiper
- Touchscreen gloves
- Meets the CE prEN13594:2012 safety standards for motorbike gloves



HUB 9918U



N-black

6 sizes XS / XXL

- Outer shell in tear-proof Polyamide
- Thermolite® thermal padding
- Fully waterproof and breathable membrane
- Hard ABS inserts on knuckles
- Anti-slip inserts on the palm
- Reflective bands
- Adjustable velcro wrist strap
- Meets the CE prEN13594:2012 safety standards for motorbike gloves



GINKO WINTER TOUCH 906DU



N-black

6 sizes XS / XXL

- Outer shell in stretch Polyester
- Thermolite® thermal padding
- Fully waterproof and breathable membrane
- Hard ABS inserts on knuckles
- Anti-slip inserts on the palm
- Adjustable velcro wrist strap
- Touchscreen gloves
- Meets the CE prEN13594:2010 safety standards for motorbike gloves



SEPIA INVERNALE 991



N-black

6 sizes XS / XXL

- Outer shell in elastic fabric
- Leather palm
- Thermolite® thermal padding
- Fully waterproof and breathable inner membrane
- Hard ABS inserts on knuckles, fingers and cuff
- Reflective band
- Adjustable velcro and neoprene wrist strap
- Visor wiper
- Meets the CE prEN13594:2010 safety standards for motorbike gloves



AVIATORE 999



N-black

6 sizes XS / XXL

- 100% real leather
- Synthetic fur lining
- Fully waterproof and breathable inner membrane
- Hard ABS inserts on knuckles and cuff
- Strengthened palm area
- Extra long cuffs with revisable synthetic fur liner
- Adjustable velcro wrist strap
- Visor wiper
- Meets the CE prEN13594:2012 safety standards for motorbike gloves



NEW SUPER INSULATOR 9928U



N-black
7 sizes XXS / XXL

- External in extra strong Oxford Polyamide
- Fleece lining
- THERMOLITE® thermal lining
- HYDROSCUD®: 100% waterproof and breathable inner membrane
- Soft D3O insert on the palm
- Reflective inserts
- Long wrist
- Velcro wrist adjustment
- Draftproof inner cuff
- Visor wiping insert
- Touchscreen gloves

NEW COLLECTION



SKINSULATOR 9929U



N-black
7 sizes XXS / XXL

- External in extra strong Oxford Polyamide
- Fleece lining
- THERMOLITE® thermal lining
- HYDROSCUD®: 100% waterproof and breathable inner membrane
- Soft D3O insert on the palm
- Reflective inserts
- Medium wrist
- Velcro wrist adjustment
- Close-fitting neoprene cuff can be worn below garment sleeves
- Visor wiping insert
- Touchscreen gloves

NEW COLLECTION



HECTOR DILUVIO 970



N-black
6 sizes XS / XXL

- Outer shell made from Polyester
- Palm in synthetic suede fabric
- Fully waterproof and breathable membrane
- Hard ABS inserts on the knuckles
- Medium cuffs
- Double adjustable velcro wrist strap
- Wrist safety tightening strap
- Visor wiper



NEW COLLECTION

SOFTY TOUCH 9926M



N-black
5 sizes S / XXL

- Outer in ultra-soft leather
- Microfibre lining
- Thinsulate™ thermal filling
- HYDROSCUD®: 100% waterproof and breathable inner membrane
- Soft D30 insert on the palm
- Medium wrist
- Cuff adjustable with elastic and velcro
- Touchscreen gloves



NEW COLLECTION

SOFTY LADY TOUCH 9927W



N-black
4 sizes XS / L

- Outer in ultra-soft leather
- Microfibre lining
- Thinsulate™ thermal filling
- HYDROSCUD®: 100% waterproof and breathable inner membrane
- Soft D30 insert on the palm
- Medium wrist
- Snap fastener closures on the cuffs
- Tailored fit
- Touchscreen gloves



MONTY TOUCH 904DM



N-black
5 sizes S / XXL

- Outer shell in elastic fabric
- Thermolite® thermal padding
- 100% breathable and waterproof inner membrane
- Anti-slip inserts on the palm
- Touchscreen gloves



MARY TOUCH 978DW



N-black
4 sizes XS / L

- Outer shell in elastic fabric
- Women's style
- Thermolite® thermal padding
- 100% breathable and waterproof inner membrane
- Anti-slip inserts on the palm
- Touchscreen gloves



PASSWORD 9919U



N-black
6 sizes XS / XXL

- Outer shell in HD Polyamide
- Fleece lining
- Thermolite® thermal padding
- Fully waterproof and breathable inside membrane
- Adjustable velcro wrist strap



URBANO 984



N-black
6 sizes XS / XXL

- Outer shell in HD coated Polyamide
- Teflon® water-repellent treatment
- Fleece lining
- Strengthened palm area
- Reflective band
- Adjustable velcro wrist strap



SOFTY SUEDE 9908



M-brown
5 sizes S / XXL

- Very soft genuine suede leather outer
- Fleece lining
- Thermolite® thermal padding
- Fully waterproof and breathable inner membrane
- Strengthened palm area
- Elasticated wrist with velcro adjustment
- External seams



SOFTY SUEDE LADY 9909



BG-beige
4 sizes XS / L

- Very soft genuine suede leather outer
- Fleece lining
- Thermolite® thermal padding
- Female style cut
- Fully waterproof and breathable inner membrane
- Strengthened palm area
- Elasticated wrist
- Tailored fit
- External seams



NEW COLLECTION

GORDON NANO 9930U



N-black
8 sizes XS / 4XL

- Waterproof backs
- Polyamide outer shell
- Polyamide lining
- HYDROSCUD®: 100% waterproof and breathable inner membrane
- Reflective inserts
- Long wrist
- Adjustable elastic wrist
- Touchscreen gloves
- Handy carrying bag with snap coupling
- Can be used as a double glove over the Tandem model (code 9931U)



NEW COLLECTION

TANDEM 9931U



N-black
6 sizes XS / XXL

- Fleece glove
- Windbreaker inserts on the back
- Reflective inserts
- Medium wrist
- Touchscreen gloves
- Can be used as an inner liner with the Gordon Nano model (code 9930U)



Thermal clothing accessories

For us at Tucano Urbano these aren't accessories... but essentials. They say you can always tell a real biker by his accessories! So, we have decided not just to look after your smallest needs, but to also let you have fun, breaking free of the humdrum city life and adding a little bit of irony. Just little things that make a big difference!



UPLOAD 6678



N-black



5 sizes S / XXL

- Long sleeved thermal vest
- Elastic Polyester
- Windbreaker inserts
- Zip fastening on the neck
- Reflective graphics
- Ideal as an undergarment



DOWNLOAD 6679



N-black



5 sizes S / XXL

- Thermal under trousers - Elastic Polyester
- Windbreaker inserts - Reflective graphics
- Ideal as an undergarment

UPLOAD LADY 6680



N-black



5 sizes XS / XL

- Long sleeved women's thermal vest
- Elastic Polyester
- Windbreaker inserts
- Zip fastening on the neck
- Reflective graphics
- Ideal as an undergarment



DOWNLOAD LADY 6681



N-black



5 sizes XS / XL

- Women's thermal under trousers
- Elastic Polyester - Windbreaker inserts
- Reflective graphics - Ideal as an undergarment

NORTH POLE 670



N-black



5 sizes S / XXL

- Long sleeved thermal vest
- Elastic Polyester
- Ideal as an undergarment



SOUTH POLE 671



N-black



5 sizes S / XXL

- Thermal under trousers
- Elastic Polyester
- Ideal as an undergarment

NORTH POLE LADY 672



N-black



5 sizes XS / XL

- Long sleeved women's thermal vest
- Elastic Polyester
- Ideal as an undergarment



SOUTH POLE LADY 673



N-black



5 sizes XS / XL

- Women's thermal under trousers
- Elastic Polyester
- Ideal as an undergarment

POLE GLOVES 669



GP- slate grey / B-black



3 sizes XS/S - M/L - XL/XXL

- Technical under gloves
- Elastic thermal Polyester



Accessories / Excalibur 100% silk

BRANCALEONE 651

N-black

3 sizes XS/S - M/L - XL/XXL

- Full face under-helmet light silk



CAPOTTE 655

N-black

One-size

- Under-helmet for open face helmets



GALAHAD 659

N-black

3 sizes XS/S - M/L - XL/XXL

- Inner gloves



MERLINO 661

N-black

One-size

- Multiuse long collar



Thermal clothing accessories

FLEECE COLLAR 615



N-black
One-size

- Double fleece
- Very warm
- Protects neck and face



FLEECE COLLAR 615AF



One-size

- Fluorescent-orange double fleece
- Very warm
- Protects neck and face

NEW COLOUR



WB FLEECE COLLAR 615WB



One-size

- Windbreaker / fleece
- 100% protection against wind and cold
- Protects neck and face



WB JET UNDER-HELMET SILK 100% 618WB



One-size

- Windbreaker / fleece
- 100% protection against wind and cold
- Protects neck and face
- Washable
- Silk cap
- Elastic adjustment



WB FULL FACE UNDER-HELMET SILK 100% 625WB



One-size

NEW COLLECTION

- Soft windbreaker / fleece
- 100% protection against wind and cold
- Protects neck and face
- Washable
- Silk cap
- Elastic adjustment



RAIN RESISTANT UNDER-HELMET 621



One-size

- Polyamide / fleece
- 100% protection against wind and water
- For full face helmet



WATER RESISTANT THROAT COLLAR 7171



One-size

- Suitable for all types of full face helmet
- 100% protection against wind and water
- Black Neoprene
- Reflective insert



WB BIB 710WB



One-size

- Windbreaker / fleece
- 100% protection against wind and cold
- Protects chest and neck



NEW COLLECTION

WB NECK WARMER 719WB



One-size

- Windbreaker / fleece
- 100% protection against wind and cold
- Protects neck and shoulders



WB COVER KNEE 721WB



One-size

- Windbreaker / fleece
- Thermal and windproof



CAPPELLO SHARPEI 695

One size

- Multi-purpose: hat or collar
- Knitted outer shell
- Stretch fleece inner
- Drawstring closure for hat



695-31 blue



695-32 black



695-34 light grey



695-47 dark grey

NEW

NEW



695-70 duck egg blue



695-71 mélangé pink



NEW



695-72 black-fluo orange



695-63 nordic



NEW



695-73 beige-grey



695-64 striped

SHARPEI 685

- Knitted multipurpose collar
- Made from Acrylic / Polyamide
- Use as a replacement for a scarf
- Use versions 34/65* as a shawl



685-45 cable black



685-52 cream



685-56 light blue



685-69 fluorescent-pink



685-61 fluorescent-orange



685-62 fluorescent-yellow



685-66 dark red



685-67 pink



685-68 teal



685-58 black



*685-65 twisted dark red



*685-34 light grey

LAGOTTO W 690

- Multi-purpose winter collar



690-77 grey



690-78 black



690-79 white



690-80 mud



690-92 mélange yellow



690-93 mélange blue



690-94 azteco



690-95 camouflage



690-96 greige

CAPPUCETTO 605

47-dark grey / 74-red
One size

- Thermal weave hood & snood
- Acrylic
- Can be used as a collar



NEW COLLECTION

BALAKOL 606

59-dark grey / 60-beige
One size

- Knitted thermal under-helmet
- Stretch fleece inner
- Can be used as a collar



TELEMARK 608

33-mélange grey / 34-light grey
One-size

- Knitted thermal under-helmet
- Acrylic
- Protects neck and face
- Can also be used as a hat / ski mask



CAPPELLO MAG 624

N-black / AF-fluorescent orange
One size

- Knitted thermal hat
- Acrylic
- Fleece lining

NEW COLOUR



COLLAR WARMER HAT

614

N-elastic fleece in black / ANE-sheepskin effect black / ARB-sheepskin effect brilliant red / RF-fluorescent pink
One size

- Multi-purpose: hat or collar
- Stretch double fleece
- Sheepskin effect versions in double fleece
- Hat closes with draw string



NEW COLOUR



NEW COLOUR

TWIST AGAIN 696

51-black

One size

- Multi-purpose: hat or collar
- Knitted outer shell
- Stretch fleece inner



MARTIN 626



B-blue / N-black / VE-green

One size

- Women's cap
- Breathable, windproof and high waterproof
Polyamide/Polyester outer
- Quilted and padded inner
- Adjustable at the rear

NEW COLLECTION



FRANCIS 627



N-black/ GS-dark grey / RS-dark red

2 sizes M / L

- Men's waterproof cap
- HYDROSCUD®:
 - Breathable Polyamide exterior, windproof and highly waterproof
 - Taped seams
- Herringbone weave fabric
- Windbreaker Jersey wool fold-away earmuffs
- Reflective inserts

NEW COLLECTION



NINJA MESSENGER 463



N-black
Cm 41 L x 14 D x 28 H
Capacity: 16 litres

- Water repellent Polyester messenger
- Anti-abrasion reinforcement on the bottom
- Integrated waterproof cover
- REFLECTIVE® SYSTEM – Visibility On Demand
- Safe compartment for electronic devices
- Mobile phone pocket on the shoulder strap
- Internal and external pockets of various sizes
- Spider holder, can also be used to fix the backpack to a scooter / bike
- Open pocket for fixing to a trolley-handle
- Removable strap for two-wheel use



Integrated waterproof cover



Open pocket for trolley-handle



Spider holder

FIND IT EASY®
 EVERYTHING IN THE RIGHT PLACE

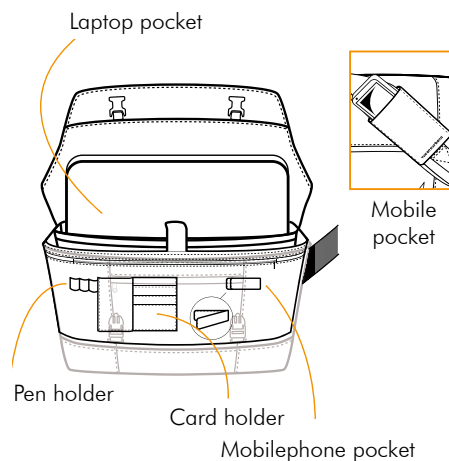

NINJA BACKPACK 462

OPTION: with CE D30 protection on the back
(code 8006)



N-black

29 cm L x 13 D x 42 H

Capacity: 18 Litres

- Water repellent Polyester backpack
- Anti-abrasion reinforcement on the bottom
- Integrated waterproof cover
- REFLECTIVE® SYSTEM - Visibility On Demand
- Protective compartment for electronic devices
- Ability to insert CE D30™ protection on the back (code 8006 - optional)
- Mobile phone pocket on the shoulder strap
- Internal and external pockets of various sizes
- Spider holder, can also be used to fix the backpack to a scooter / bike



Integrated waterproof cover



Spider holder

FIND IT EASY®
EVERYTHING IN THE RIGHT PLACE

Mobile pocket



Ability to insert D30™ CE protection

Laptop pocket

NINJA LEG BAG 464



N-black

cm 15 L x 4 D x 20 H

Capacity: 1.2 Litres

- Leg bag made from water repellent Polyester
- Anti-abrasion reinforcement on the bottom
- Waterproof zippers
- Three pockets: mobile phone, wallet / document
- Key hook
- Can also be used as a pouch or shoulder bag

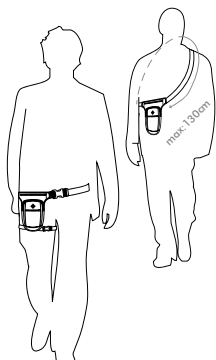

Can also be used as a pouch or shoulder bag.

FIND IT EASY®
EVERYTHING IN THE RIGHT PLACE

Document pocket

Waterproof zippers

Key hook

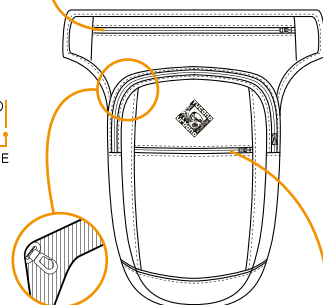

Mobilephone pocket

HELMET BAG 439



N-black

- Waterproof Polyamide bag for helmet storage with shoulder straps
- Inner lining in scratchproof fabric
- Fitted with loops to enable bag to be chained to a motorcycle



WATERPROOF BAG SMALL SIZE 473



N-black / Capacity: 40 litres

- Fully waterproof bag
- Coated Polyamide, high frequency welded
- Mono-shoulder strap for carrying by hand or over the shoulder
- Bands and loops for fixing on the rack
- External pocket in mesh
- Valve for inflating or deflating for extra compact



SMALL OFF-ROAD BAG 455

455

N-black

Capacity: 13/18 litres

BIG OFF-ROAD BAG 457

457

N-black

Capacity: 21/30 litres

- Bags in heavy Polyester
- Fixing magnets
- Big zip-fastener
- Waterproof cover
- Waterproof map-holder
- Leather fittings
- Folding space to increase volume
- Small cable as anti-theft
- Reflective logos
- Can be carried over the shoulder or using the handle



NANO BACKPACK 478



NT-black titanium
cm 29 L x 12 D x 42 H
Capacity: 14 Litres
Max load 10 Kg

- Water-repellent, super-compact backpack
- Polyester outer shell
- Zip closure
- Reflective logo and print
- Padded shoulder straps
- Transport handle for attaching to scooters
- Pocket transforms into a compact pouch with hook



NANO DUFFLE BAG 474



NT-black titanium
cm 54 L x 23 D x 27 H
Capacity: 33 Litres
Max load 10 Kg

- Water-repellent, super-compact bag for sport/leisure
- Polyester outer shell
- Zip closure
- Reflective logo and print
- Can be carried over the shoulder or using a handle
- Inside pocket transforms into a compact pouch with hook



NANO POCLETTE 475



NT-black titanium
cm 27 L x 11.5 D x 13.5 H
Capacity: 4 Litres
Max load 4 Kg

- Water-repellent, super-compact beauty clutch
- Polyester outer shell
- Zip closure
- Reflective logo and print
- Can be carried using its handle
- Pocket transforms into a compact pouch with hook



NANO SHOPPER BAG 476



NT-black titanium
cm 40 L x 36 H
Capacity: 5 Litres
Max load 5 Kg

- Water-repellent, super-compact shopper bag
- Polyester outer shell
- Elasticated hem to hold purchases
- Reflective logo and print
- Can be carried using a handle
- Pocket transforms into a compact pouch with hook



NANO FAMILY SHOPPER BAG 477



NT-black titanium
cm 56 L x 32 D x 37 H
Capacity: 66 Litres
Max load 10 Kg

- Water-repellent, super-compact shopping cart bag
- Polyester outer shell
- Elasticated hem to hold purchases
- Hooks for attaching to cart
- Reflective logo and print
- Transport by handle for scooter fixing and by shoulder strap for bike use
- Pocket transforms into a compact pouch with hook



Accessories

CINTUCA 642

N-black

3 sizes:

XS/S (cm 65-80)

M/L (cm 90-105)

XL/XXL (cm 115-130)

- Elasticated kidney belt
- Double 3D Aero layers for maximum breathability
- Ergonomic lumbar support
- Elasticated adjustment on the sides for maximum grip
- Single central fastening



SMOGGY 643

N-black / GR-grey / AZ-light blue

Exchange filters 816-F

- Antismog mask with electrostatic and active carbon filter
- Protection against fine dust particles and solvents
- Anti condensation valve
- Cover made from washable and super-breathable technical mesh
- 2 exchange filters included



PANAMA 315

One-size

- Helmet liner in rattan
- Universal model for jet or full face helmet
- Creates an air space for maximum freshness and hygiene
- Patent pending



PATENT PENDING

PAPAM 319

(Pack of 2 pieces)

GR-grey

One-size

- Helmet liner in Aero 3D
- Universal model for jet or full face helmet
- Protects and provides maximum hygiene for the inside of the helmet
- Machine washable - Sold in box of 25 packs (code 319BOX)



ATOLLO NEOPRENE 317

Different patterns

- Helmet stand for home and office
- Made from neoprene
- When the helmet is stored upside down, items such as keys, gloves, under-helmet, collar can be placed inside without damaging the helmet
- Ideal storage for your helmet
- Protect helmet from dirt and scrapes



317-05 Anni '60



317-01 Tucano Urbano

Accessories

SHOE PROTECTOR 313

Black

- Shoe protector in elasticised material with a leather reinforcement and a Velcro tab to adjust to all sizes



FOOT ON 314

12-black / 13-green

- Shoe protector to fit directly onto the gear shift lever (Allen key included)
- Ergonomic design for maintaining sensitivity and protecting the shoe
- Washable
- Patent pending



PATENT PENDING

RIPARI - BIKE COVERS

216/218/220/222/224

216 Small scooters

218 Small scooters with top case and windscreen

220 Maxiscooter and road bike

222 Off-road and custom-bike

224 Honda Gold Wing



Brown
One-size

- Motorcycle and scooter covers in waterproof coated Polyester
- Lining in Polyester
- Built-in metal eyelet
- Taped seams
- Convenient storage sack



Accessories

FLOWERS 345

- Decorative fabric flowers for scooters and motorbikes
- Universal patented attachment system
- Sold in box of 10 units (code 345BOX)



Sunflower



Daisy



Rose



Peony



Peonia



Lotus flower



Lotus flower



Orchid



Orchid



Universal patented attachment system

HELMET EARS TM

- Decorative ears for crash helmets
- Resistant to high speed
- Stickers included for porous or scratched surfaces use

- 010 Bear**
- 020 Pinkie Pig**
- 050 Leopard**
- 065 Sheep**
- 075 Donkey**
- 080 Cat tail and ears**
- 085 Mouse**
- 090 Devil horns and tail**



Bear
TM-010



Pinkie Pig
TM-020



Leopard TM-050



Sheep TM-065



Donkey TM-075



Cat tail and ears
TM-080



Mouse TM-085



Devil horns and tail
TM-090

1272 LETTERS&CO

- 3D letters and numbers stickers
- Box of 10 packs



Safety

For us safety means not just protection but also visibility and comfort. Travelling safely on 2 wheels means protecting yourself actively by wearing appropriate clothing (even in summer you can stay protected without melting in the process), by ensuring that you can be seen, by day and by night, in rain or fog (even a small reflector is enough to ward off potentially serious danger), and making sure that you feel as comfortable as possible so you can fully concentrate on the road.

Travelling by bike is more comfortable when wearing waterproof and breathable clothing that keeps your body at the right temperature, when any baggage carriers are balanced and do not cause obstructions, and when clothing and accessories are used that block wind even at high speed.



EL'MET 1100

9 head size fittings XXS / XXL

Shell in 3 sizes: small / medium / large

- ECE 22.05 approved in Italy
- Fibreglass shell in 3 sizes
- Removable and washable eco leather and Polyester inner
- Padded inserts for precise fit adjustment included
- Additional covers for use without a visor
- Reflective graphics
- Strap with micrometric closure
- Long visor included

Optional accessories and spare parts:

- Code 1250-01

Long transparent visor

- Code 1251-01

Goggle shaped visor

- Code 1270

Removable eco leather and Polyester inner

- Code 1260

Cover V: mounting plates for use with visor, with screws

- Code 1261

Cover SV: mounting plates for use without a visor, with screws

SHELL	SIZE	SMALL			MEDIUM			LARGE		
		XXS	XS	S1	S2	M	L	XL1	XL2	XXL
		52	54	55	56-57	57	58	59	60	61
CODE	COLOUR									
1100-21	matte black	o	X	X	X	X	X	X	o	X
1100-40	pastel pink	o	X	X	X	X	o	o		
1100-41	signal orange	o	X	o	X	X	X	o		
1100-42	light turquoise	o	X	o	X	X	X	o		
1100-43	deep blue				X	X	X	X	o	X
1100-44	matte green				X	X	X	X	o	X
1100-30	ice white				X	X	X	X	o	X
1100-45	dark grey				X	X	X	X	o	X
1100-48	lacquer red				X	X	X	X	o	X
1100-49	pastel green				X	X	X	X		
1100-51	fluorescent-yellow	o	X	o	X	X	X	X	o	X
1100-52	fluorescent-orange	o	X	o	X	X	X	X	o	X
1100-54	fluorescent-light blue	o	X	o	X	X	X	X		
1100-55	El'met Pad				X	X	X	X		
1100-57	matte dark blue	o	X	o	X	X	X	X	o	X
1100-58	matte dark grey	o	X	o	X	X	X	X	o	X

X = models of helmets available
o = models available ordering inner lining corresponding to the required size (code 1270)

Removable inner linings for sizes XXS / XS / S1 are compatible with the small shell and interchangeable

Removable inner lining of sizes S2 / M / L / XL1 are compatible with the medium shell and interchangeable

Removable inner lining of sizes XL2 / XXL are compatible with the large shell and interchangeable



COLOUR



ice white 1100-30



pastel pink 1100-40



signal orange 1100-41



light turquoise 1100-42



deep blue 1100-43



dark grey 1100-45



lacquer red 1100-48



pastel green 1100-49

MATTE



matte black 1100-21



matte green 1100-44



matte dark blue 1100-57



matte dark grey 1100-58

FLUO



fluorescent-yellow 1100-51



fluorescent-orange 1100-52



fluorescent-light blue
1100-54

EL'MET PAD



El'met Pad 1100-55



Bag for helmet



Removable and washable inner lining



Goggle shaped visor



Reflective graphics

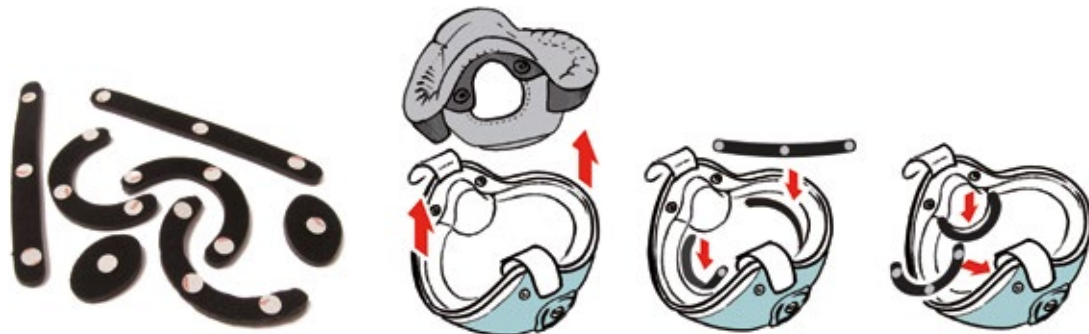

Padded inserts for precise fit adjustment included

MODULO AIRBAG AB 8000

2 sizes

Small, adjustable for all women's sizes

Large, adjustable for all men's sizes

- MOTOAIRBAG® module inside
- Certified in accordance with the back protector norm EN 1621-2 (2003) Level 2, when inflated, even if worn on its own
- Patented product
- System compatible with all purpose designed jackets
- Waterproof fitting system for rainwear jackets
- Can also be worn on jackets fitted with elbow and shoulder armour
- Optional, easy to use recharging kit
- Fully inflated in 80 milliseconds
- Patented cold inflation MOTOAIRBAG® (CO2)
- Mechanical activation

Powered by



8000R1 CANNISTER + THREADED REFILL TOOL

8000A1 COOL PAD small

- 3D Aero mesh back padding

8000A2 COOL PAD large

- 3D Aero mesh back padding

8000A3 ADDITIONAL POCKET



D3O™ 1 ELBOW ARMOUR 8002



- CE prEN 1621-1:2011 approved elbow armour (pair) – Level 1 (standard protection)
- D3O™: soft and comfortable material during use; on impact, the material hardens improving shock absorption and protection for the user



D3O™ 2 ELBOW ARMOUR 8003



- CE prEN 1621-1:2011 approved elbow armour (pair) – Level 2 (maximum protection)
- D3O™: soft and comfortable material during use; on impact, the material hardens improving shock absorption and protection for the user



D3O™ 1 SHOULDER ARMOUR 8004



- CE prEN 1621-1:2011 approved shoulder armour (pair) – Level 1 (standard protection)
- D3O™: soft and comfortable material during use; on impact, the material hardens improving shock absorption and protection for the use



D3O™ 2 SHOULDER ARMOUR 8005



- CE prEN 1621-1:2011 approved shoulder armour (pair) – Level 2 (maximum protection)
- D3O™: soft and comfortable material during use; on impact, the material hardens improving shock absorption and protection for the user



D3O™ 1 KNEE ARMOUR 8007



- CE prEN 1621-1:2011 approved knee armour (pair) - Level 1 (standard protection)
- D3O™: soft and comfortable material during use; on impact, the material hardens improving shock absorption and protection for the user



D3O™ 1 BACK ARMOUR FOR POCKET 8006



(armour dimension: 44 cm)

- CE EN 1621-2 approved back protector for pocket – Level 1 (standard protection)
- D3O™: soft and comfortable material during use; on impact, the material hardens improving shock absorption and protection for the user



D3O™ 1 HIP ARMOUR 8008



- CE prEN 1621-1:2011 approved hip armour (pair) - Level 1 (standard protection)
- D3O™: soft and comfortable material during use; on impact, the material hardens improving shock absorption and protection for the user



CE APPROVED BACK PROTECTOR 809



2 sizes

code 809-1: Small (waist-shoulder 42 cm)

code 809-2: Large (waist-shoulder 46 cm)

- CE EN 1621-2/03 type B1 approved back protector



Brand	Model	Code	SGAS**			Brand	Model	Code	SGAS**		
			cm.62	cm.72	cm.82				cm.62	cm.72	cm.82
Aprilia	Atlantic Sprint 125/200/250/300/400/500 (from 2005)	071			*	Honda	SH Mode	019 *	*		
Aprilia	Atlantic 125/500 (until 2004)	040	1+1			Honda	SWT 400/600	074	*		*
Aprilia	Leonardo 125/150/250/300	017 *	*			Honda	Silver Wing 400/600 (until 2008)	036	*	*	
Aprilia	Scarabeo 250/300/400/500 (from 2006)	156		*		Honda	S-Wing 125/150	067			*
Aprilia	Scarabeo 125/150/200/250 (until 2005)	019 *	*			Honda	Vision 50/110	017 *	*		
Aprilia	Scarabeo 125/200 (from 2007)	049 *	*			Honda	Zoomer	151 *	*		
Aprilia	Scarabeo 50/100	019 *	*			Italjet	Jack (Torpedo from 2006)	049 *	*		
Aprilia	Scarabeo 500 (until 2005)	041	*	*		Italjet	Jet-Set 150	151 *	*		
Aprilia	Sport City 200	049 *	*			Italjet	Millennium 125/150	021		*	
Aprilia	Sport City CUBE 125/200/250/300	049 *	*			Italjet	Torpedo 50/125/150	019 *	*		
Aprilia	Sport City One 50/125	017 *	*			Kawasaki	J300	169		*	
Aprilia	SR	017 *	*			Kymco	Agility	017 *	*		
Aprilia	SR Max	043		*		Kymco	Agility City	017 *	*		
Aprilia	SRV 850	072			*	Kymco	Bet & Win 50/125/150/250	151 *	*		
Benelli	491 st/rr	017 *	*			Kymco	Dink / Spacer 50/125/150/200	029 *		*	
Benelli	Adiva	035	*			Kymco	Yager 50/125/200 (from 2006)	065			*
Betamotor	Eikon 50 /125/150	029 *		*		Kymco	Dink Street (Super Dink) 125/200/300	078		*	
BMW	C 1 125/200	034	*			Kymco	G-Dink (Yager) 125/300 (from 2012)	087			*
BMW	C 600 Sport	097			*	Kymco	Gran Dink 125/150/250	029 *		*	
BMW	C 650 GT	098		*		Kymco	K-XCT 125/300 (from 2013)	162			*
Cagiva	Cucciolo / Nuvola 50/125	019 *	*			Kymco	Like 50/125/150/200	151 *	*		
Garelli	Astro 50 (FX50)	151 *	*			Kymco	MovieXL 125/150	017 *	*		
Garelli	Flò	151 *	*			Kymco	People 50/125/150/250	019 *	*		
Garelli	Match	017 *	*			Kymco	People S 250/300	049 *	*		
Garelli	PMX sport/rally (KRC/KRS)	019 *	*			Kymco	People S 300 iniezione (2008)	049 *	*		
Garelli	R303	151 *	*			Kymco	New Fly (from 2013)	066	*		
Garelli	Starter	017 *	*			Kymco	My Road 700	086			*
Garelli	T-Rex 125/150 (Freeland)	017 *	*			Kymco	People GT/GTI 125/200/300	083			*
Gilera	Fuoco	062/062EV		*		Kymco	People One 125 (from 2013)	168		*	
Gilera	GP800	072			*	Kymco	People S 50/125/200	066	*		
Gilera	Nexus 125/250/300/500	043		*		Kymco	Xciting 250/300/500 (until 2012)	046		*	
Gilera	Runner 50/125/200 (from 2006)	158			*	Kymco	Xciting 400 (from 2013)	166			*
Gilera	Runner 50/125/180/200 (until 2005)	018 *	*			Kymco	Xciting R 250/300/500 (until 2012)	046		*	
Honda	@ Nes 125/150 ES	152C *		*		Linhai	Main Street	029 *		*	
Honda	CN 250	025		Not equipped		Malaguti	Blog	075			*
Honda	Dylan 125/150	152C *		*		Malaguti	Centro 125/160 (from 2008)	049 *	*		
Honda	Foresight 250	029 *		*		Malaguti	Centro 50 (until 2008)	151 *	*		
Honda	Forza (until 2012)	050	*			Malaguti	Centro 50 (from 2009)	049 *	*		
Honda	Forza 300 (from 2013)	164		*		Malaguti	Ciak 50/100/125/150	019 *	*		
Honda	Forza X (until 2012)	050	*			Malaguti	Madison	029 *		*	
Honda	Integra 700 (from 2012 until 2013)	095			*	Malaguti	Password	049 *	*		
Honda	Integra 750 (from 2014)	195/195EV		*		Malaguti	Phantom Max 200/250	017 *	*		
Honda	Jazz	040	1+1			Malaguti	Spider Max	047			*
Honda	Lead 100	017 *	*			MBK	Booster 50/100	017 *	*		
Honda	Lead 110	017 *	*			MBK	Dodo 125/150	151 *	*		
Honda	Pantheon 125/150 (until 2002)	029 *		*		MBK	Evolis	017 *	*		
Honda	Pantheon 125/150 (from 2003)	039		*		MBK	Stunt	151 *	*		
Honda	PCX 125/150	082			*	MBK	Fizz	151 *	*		
Honda	PS 125/150	161		*		MBK	Flame 125 (until 2003)	017 *	*		
Honda	SH 125/150 SHi 125/150 (from 2001 until 2008)	049 *	*			MBK	Flame X (from 2004)	068			*
Honda	SH 125/150 (from 2009 until 2012)	079	*			MBK	Flipper	019 *	*		
Honda	SH 125/150 (from 2013)	099		*		MBK	Forte	017 *	*		
Honda	SH 300 (until 2010)	064	*			MBK	Cityliner	152C *			*
Honda	SH 300 (from 2011)	084/084EV	*			MBK	Kilibre	152C *			*
Honda	SH 50 (until 2000)	013 *	*			MBK	Mach 50	017 *	*		
Honda	SH 50/100	019 *	*			MBK	Nitro 50/100	017 *	*		
						MBK	Oceo 125 (from 2012)	090			*

Brand	Model	Code	SGAS**		
			cm.62	cm.72	cm.82
MBK	Ovetto 50/100	151 *	*		
MBK	Skycruiser (until 2009)	155		*	
MBK	Skycruiser 125/250 (from 2010)	080			*
MBK	Skyliner 125/150/180	038		*	
MBK	Skyliner 250 (until 1999)	029 *		*	
MBK	Skyliner 250 (from 2000)	160	*		
MBK	Thunder 125/150	017 *	*		
MBK	Waap	017 *	*		
MBK	Vertex	017 *	*		
Peugeot	Citystar	171			
Peugeot	Elyseo 50/100/125/150	031 *	*		
Peugeot	Elystar 125/150	031 *	*		
Peugeot	Geopolis	152C *		*	
Peugeot	Looxor 50/100/125/150	019 *	*		
Peugeot	Ludix	017 *	*		
Peugeot	Metropolis 3 wheels	173EV			
Peugeot	Satelis 125/250/400/500	157	*		
Peugeot	Satelis 300 (from 2013)	157	*		
Peugeot	V-Clic	017 *	*		
Peugeot	Vivacity 50/100/125	151 *	*		
Peugeot	X-fight (Race) 50/100	017 *	*		
Piaggio	Beverly (Tourer/Cruiser) 200/250/400/500	152C *		*	
Piaggio	Beverly 125/300 (until 2010)	152C *		*	
Piaggio	Beverly 10° Anniversario	152C *		*	
Piaggio	Beverly 125ie / 300ie / 350 (from 2010)	081		*	
Piaggio	Beverly Sport Touring	081		*	
Piaggio	Camaby Cruiser 125/200/250/300	049 *	*		
Piaggio	Camaby 125/200/250/300	049 *	*		
Piaggio	Fly (until 2012)	151 *	*		
Piaggio	Fly 125 (from 2013)	151 *	*		
Piaggio	Hexagon 125/180/250	021		*	
Piaggio	Liberty 50/125/150/200	019 *	*		
Piaggio	MP3 / MP3 Touring / MP3 400 LT / MP3 500 Sport / MP3 500 Business (until 2013)	062/062EV		*	
Piaggio	MP3 Hybrid	062/062EV		*	
Piaggio	MP3 from 2014	062C/062EV		*	
Piaggio	MP3 Yourban	085/085EV		*	
Piaggio	Vespa ET2/ET4	151 *	*		
Piaggio	Vespa GT/GTS/GTV/L (from 2007)	154/154EV			*
Piaggio	Vespa LX/LXV/S (from 2007)	153	*		
Piaggio	Vespa PK/PX/HP	013 *	*		
Piaggio	Vespa Primavera	170		*	
Piaggio	X7 / X7 Evo	070			*
Piaggio	X8	045	*	*	
Piaggio	X9 125/150/200/250/500 (evol.)	032		*	
Piaggio	X10 125/350/500 (from 2012)	096		*	
Piaggio	Xevo	045	*	*	
Quadro	350D (from 2012)	094		*	
Quadro	350S (from 2013)	094		*	
Quadro	Parkour (from 2013)	094			
Suzuki	Burgman 125/150 (until 2006)	048	*		
Suzuki	Burgman 125/150/200 (Executive) (from 2007 until 2013)	063	*		
Suzuki	Burgman 250/400 I.E. (from 2003 until 2006)	042	*	*	
Suzuki	Burgman 250/400 (until 2002)	031 *	*		
Suzuki	Burgman 400 (from 2006)	159			*

Brand	Model	Code	SGAS**		
			cm.62	cm.72	cm.82
Suzuki	Burgman 650 (until 2012)	037	*	*	
Suzuki	Burgman 650 (from 2013)	165/165EV			*
Suzuki	Sixteen	049 *	*		
Suzuki	UC Epicuro 125/150	151 *	*		
Sym	HD2	049 *	*		
Sym	HD 125/200 EVO	049 *	*		
Sym	Jet Sport X 50	017 *	*		
Sym	GTS (RV/Voyager) 125/250/300 (from 2012)	163			*
Sym	GTS (RV/Voyager) 125/250 (until 2011)	077			*
Sym	GTS (RV/Voyager) Evo 300 (until 2011)	077			*
Sym	Joyride 125/150/200	031 *	*		
Sym	Joyride Evo 125/200	076			*
Sym	Maxsym 400	088			*
Sym	Mio 50/100	151 *	*		
Sym	Symphony 50/125/150	019 *	*		
Sym	Super Duke 125	017 *	*		
Sym	Citycom 300	073			*
Sym	VS 125/150	017 *	*		
Yamaha	3City	172			
Yamaha	Aerox 50/100	017 *	*		
Yamaha	Breeze	151 *	*		
Yamaha	BW'S o BWS 50/100/125 (until 2008)	017 *	*		
Yamaha	BW'S o BWS 50/100/125 (from 2009)	017 *	*		
Yamaha	Cygnus (until 2003)	017 *	*		
Yamaha	Cygnus X (from 2004)	068			*
Yamaha	D'elight (from 2013)	151 *	*		
Yamaha	Equalis	017 *	*		
Yamaha	Jog R 50	017 *	*		
Yamaha	Majesty 125/150/180	038			*
Yamaha	Majesty 250 (from 2000)	160	*		
Yamaha	Majesty 250 (until 1999)	029 *			*
Yamaha	Majesty 400	044			*
Yamaha	Maxter 125/150	017 *	*		
Yamaha	Neo's 50/100	151 *			*
Yamaha	Slider	151 *	*		
Yamaha	Teo's	151 *	*		
Yamaha	T-Max (until 2007)	033	*		*
Yamaha	T-Max (from 2008 until 2011)	069	*		*
Yamaha	T-Max 530 (from 2012)	089/089EV			*
Yamaha	Vity	017 *	*		
Yamaha	Versity (XC 300)	152C *			*
Yamaha	Why 50	019 *	*		
Yamaha	XC 125/150 (Fly One/Cygnus)	017 *	*		
Yamaha	X-City 125/250/300	152C *			*
Yamaha	X-Max 125/250 (until 2009)	155			*
Yamaha	X-Max 125/250 (from 2010 until 2013)	080			*
Yamaha	X-Max 125/250 (from 2014)	167/167EV			*
Yamaha	X-Max 400 (from 2013)	167/167EV			*
Yamaha	Xenter 125/150 (from 2012)	090			*

* Suggested compatibility. Confirm actual fitting with your mechanic.

** SGAS - Inflatable recommended compatibility

 Also available in EVO version

 Only available in EVO version

Code	Brand	Model	SGAS**			Code	Brand	Model	SGAS**		
			cm.62	cm.72	cm.82				cm.62	cm.72	cm.82
013 *	Honda	SH 50 (until 2000)	*			025	Honda	CN 250			Not equipped
013 *	Piaggio	Vespa PK/PX/HP	*			029 *	Betamotor	Eikon 50 /125/150		*	
017 *	Aprilia	Leonardo 125/150/250/300	*			029 *	Honda	Foresight 250		*	
017 *	Aprilia	Sport City One 50/125	*			029 *	Honda	Pantheon 125/150 (until 2002)		*	
017 *	Aprilia	SR	*			029 *	Kymco	Dink / Spacer 50/125/150/200		*	
017 *	Benelli	491 st/rr	*			029 *	Kymco	Gran Dink 125/150/250		*	
017 *	Garelli	Match	*			029 *	Linhai	Main Street		*	
017 *	Garelli	Starter	*			029 *	Malaguti	Madison		*	
017 *	Garelli	T-Rex 125/150 (Freeland)	*			029 *	MBK	Skyliner 250 (until 1999)		*	
017 *	Honda	Lead 100	*			029 *	Yamaha	Majesty 250 (until 1999)		*	
017 *	Honda	Lead 110	*			031 *	Peugeot	Elyseo 50/100/125/150	*		
017 *	Honda	Vision 50/110	*			031 *	Peugeot	Elystar 125/150	*		
017 *	Kymco	Agility	*			031 *	Suzuki	Burgman 250/400 (until 2002)	*		
017 *	Kymco	Agility City	*			031 *	Sym	Joyride 125/150/200	*		
017 *	Kymco	MovieXL 125/150	*			032	Piaggio	X9 125/150/200/250/500 (evol.)		*	
017 *	Malaguti	Phantom Max 200/250	*			033	Yamaha	T-Max (until 2007)	*		*
017 *	MBK	Booster 50/100	*			034	BMW	C 1 125/200	*		
017 *	MBK	Evolis	*			035	Benelli	Adiva	*		
017 *	MBK	Flame 125 (until 2003)	*			036	Honda	Silver Wing 400/600 (until 2008)	*	*	
017 *	MBK	Forte	*			037	Suzuki	Burgman 650 (until 2012)	*	*	
017 *	MBK	Mach 50	*			038	MBK	Skyliner 125/150/180		*	
017 *	MBK	Nitro 50/100	*			038	Yamaha	Majesty 125/150/180		*	
017 *	MBK	Thunder 125/150	*			039	Honda	Pantheon 125/150 (from 2003)		*	
017 *	MBK	Waap	*			040	Aprilia	Atlantic 125/500 (until 2004)	1+1		
017 *	MBK	Vertex	*			040	Honda	Jazz	1+1		
017 *	Peugeot	Ludix	*			041	Aprilia	Scarabeo 500 (until 2005)	*	*	
017 *	Peugeot	V-Clic	*			042	Suzuki	Burgman 250/400 I.E. (from 2003 until 2006)	*	*	
017 *	Peugeot	X-fight (Race) 50/100	*			043	Aprilia	SR Max		*	
017 *	Sym	Jet Sport X 50	*			043	Gilera	Nexus 125/250/300/500		*	
017 *	Sym	Super Duke 125	*			044	Yamaha	Majesty 400			*
017 *	Sym	VS 125/150	*			045	Piaggio	X8	*	*	
017 *	Yamaha	Aerox 50/100	*			045	Piaggio	Xevo	*	*	
017 *	Yamaha	BWS o BWS 50/100/125 (until 2008)	*			046	Kymco	Xciting 250/300/500 (until 2012)		*	
017 *	Yamaha	BWS o BWS 50/100/125 (from 2009)	*			046	Kymco	Xciting R 250/300/500 (until 2012)		*	
017 *	Yamaha	Cygnus (until 2003)	*			047	Malaguti	Spider Max		*	
017 *	Yamaha	Equalis	*			048	Suzuki	Burgman 125/150 (until 2006)	*		
017 *	Yamaha	Jog R 50	*			049 *	Aprilia	Scarabeo 125/200 (from 2007)	*		
017 *	Yamaha	Maxter 125/150	*			049 *	Aprilia	Sport City 200	*		
017 *	Yamaha	Vity	*			049 *	Aprilia	Sport City CUBE 125/200/250/300	*		
017 *	Yamaha	XC 125/150 (Fly One/Cygnus)	*			049 *	Honda	SH 125/150 SHi 125/150 (from 2001 until 2008)	*		
018 *	Gilera	Runner 50/125/180/200 (until 2005)	*			049 *	Italjet	Jack (Torpedo from 2006)	*		
019 *	Aprilia	Scarabeo 125/150/200/250 (until 2005)	*			049 *	Kymco	People S 250/300	*		
019 *	Aprilia	Scarabeo 50/100	*			049 *	Kymco	People S 300 iniezione (2008)	*		
019 *	Cagiva	Cucciolo / Nuvola 50/125	*			049 *	Malaguti	Centro 125/160 (from 2008)	*		
019 *	Garelli	PMX sport/rally (KRC/KRS)	*			049 *	Malaguti	Centro 50 (from 2009)	*		
019 *	Honda	SH 50/100	*			049 *	Malaguti	Password	*		
019 *	Honda	SH Mode	*			049 *	Piaggio	Carnaby Cruiser 125/200/250/300	*		
019 *	Italjet	Torpedo 50/125/150	*			049 *	Piaggio	Carnaby 125/200/250/300	*		
019 *	Kymco	People 50/125/150/250	*			049 *	Suzuki	Sixteen	*		
019 *	Malaguti	Ciak 50/100/125/150	*			049 *	Sym	HD2	*		
019 *	MBK	Flipper	*			049 *	Sym	HD 125/200 EVO	*		
019 *	Peugeot	Loxor 50/100/125/150	*			050	Honda	Forza (until 2012)	*		
019 *	Piaggio	Liberty 50/125/150/200	*			050	Honda	Forza X (until 2012)	*		
019 *	Sym	Symphony 50/125/150	*			062/062EV	Gilera	Fuoco		*	
019 *	Yamaha	Why 50	*			062/062EV	Piaggio	MP3 / MP3 Touring / MP3 400 LT / MP3 500 Sport / MP3 500 Business (until 2013)		*	
021	Italjet	Millennium 125/150			*						
021	Piaggio	Hexagon 125/180/250			*						

Code	Brand	Model	SGAS**		
			cm.62	cm.72	cm.82
062/062EV	Piaggio	MP3 Hybrid		*	
062C/062EV	Piaggio	MP3 from 2014		*	
063	Suzuki	Burgman 125/150/200 (Executive) (from 2007 until 2013)	*		
064	Honda	SH 300 (until 2010)	*		
065	Kymco	Yager 50/125/200 (from 2006)			*
066	Kymco	New Fly (from 2013)	*		
066	Kymco	People S 50/125/200	*		
067	Honda	S-Wing 125/150			*
068	MBK	Flame X (from 2004)		*	
068	Yamaha	Cygnus X (from 2004)		*	
069	Yamaha	T-Max (from 2008 until 2011)	*		*
070	Piaggio	X7 / X7 Evo			*
071	Aprilia	Atlantic Sprint 125/200/250/300/400/500 (from 2005)			*
072	Aprilia	SRV 850			*
072	Gilera	GP800			*
073	Sym	Citycom 300			*
074	Honda	SWT 400/600	*		*
075	Malaguti	Blog			*
076	Sym	Joyride Evo 125/200			*
077	Sym	GTS (RV/Voyager) 125/250 (until 2011)			*
077	Sym	GTS (RV/Voyager) Evo 300 (until 2011)			*
078	Kymco	Dink Street (Super Dink) 125/200/300		*	
079	Honda	SH 125/150 (from 2009 until 2012)	*		
080	MBK	Skycruiser 125/250 (from 2010)			*
080	Yamaha	X-Max 125/250 (from 2010 until 2013)			*
081	Piaggio	Beverly 125ie / 300ie / 350 (from 2010)		*	
081	Piaggio	Beverly Sport Touring		*	
082	Honda	PCX 125/150			*
083	Kymco	People GT/GTI 125/200/300		*	
084/084EV	Honda	SH 300 (from 2011)	*		
085/084EV	Piaggio	MP3 Yourban		*	
086	Kymco	My Road 700		*	
087	Kymco	G-Dink (Yager) 125/300 (from 2012)			*
088	Sym	Maxsym 400			*
089/084EV	Yamaha	T-Max 530 (from 2012)			*
090	MBK	Oceo 125 (from 2012)		*	
090	Yamaha	Xenter 125/150 (from 2012)		*	
094	Quadro	350D (from 2012)		*	
094	Quadro	350S (from 2013)		*	
094	Quadro	Parkour (from 2013)	*		
095	Honda	Integra 700 (from 2012 until 2013)			*
096	Piaggio	X10 125/350/500 (from 2012)		*	
097	BMW	C 600 Sport			*
098	BMW	C 650 GT		*	
099	Honda	SH 125/150 (from 2013)		*	
151 *	Garelli	Astro 50 (FX50)	*		
151 *	Garelli	Flò	*		
151 *	Garelli	R303	*		
151 *	Honda	Zoomer	*		
151 *	Italjet	Jet-Set 150	*		
151 *	Kymco	Bet & Win 50/125/150/250	*		
151 *	Kymco	Like 50/125/150/200	*		
151 *	Malaguti	Centro 50 (until 2008)	*		
151 *	MBK	Doodo 125/150	*		
151 *	MBK	Stunt	*		

Code	Brand	Model	SGAS**		
			cm.62	cm.72	cm.82
151 *	MBK	Fizz	*		
151 *	MBK	Ovetto 50/100	*		
151 *	Peugeot	Vivacity 50/100/125	*		
151 *	Piaggio	Fly (until 2012)	*		
151 *	Piaggio	Fly 125 (from 2013)	*		
151 *	Piaggio	Vespa ET2/ET4	*		
151 *	Suzuki	UC Epicuro 125/150	*		
151 *	Sym	Mio 50/100	*		
151 *	Yamaha	Breeze	*		
151 *	Yamaha	D'Elight (from 2013)	*		
151 *	Yamaha	Neo's 50/100	*		
151 *	Yamaha	Slider	*		
151 *	Yamaha	Teo's	*		
152C *	Honda	@ Nes 125/150 ES		*	
152C *	Honda	Dylan 125/150		*	
152C *	MBK	Cityliner		*	
152C *	MBK	Kilibre		*	
152C *	Peugeot	Geopolis		*	
152C *	Piaggio	Beverly (Tourer/Cruiser) 200/250/400/500		*	
152C *	Piaggio	Beverly 125/300 (until 2010)		*	
152C *	Piaggio	Beverly 10° Anniversario		*	
152C *	Yamaha	Versity (XC 300)		*	
152C *	Yamaha	X-City 125/250/300		*	
153	Piaggio	Vespa LX/LXV/S (from 2007)	*		
154/154EV	Piaggio	Vespa GT/GTS/GTV/L (from 2007)			*
155	MBK	Skycruiser (until 2009)		*	
155	Yamaha	X-Max 125/250 (until 2009)		*	
156	Aprilia	Scarabeo 250/300/400/500 (from 2006)		*	
157	Peugeot	Satelis 125/250/400/500	*		
157	Peugeot	Satelis 300 (from 2013)	*		
158	Gilera	Runner 50/125/200 (from 2006)			*
159	Suzuki	Burgman 400 (from 2006)			*
160	MBK	Skyliner 250 (from 2000)	*		
160	Yamaha	Majesty 250 (from 2000)	*		
161	Honda	PS 125/150		*	
162	Kymco	K-XCT 125/300 (from 2013)			*
163	Sym	GTS (RV/Voyager) 125/250/300 (from 2012)			*
164	Honda	Forza 300 (from 2013)		*	
165/165EV	Suzuki	Burgman 650 (from 2013)			*
166	Kymco	Xciting 400 (from 2013)			*
167/167EV	Yamaha	X-Max 125/250 (from 2014)			*
167/167EV	Yamaha	X-Max 400 (from 2013)			*
168	Kymco	People One 125 (from 2013)		*	
169	Kawasaki	J300		*	
170	Piaggio	Vespa Primavera		*	
171	Peugeot	Citystar			
172	Yamaha	3City			
173EV	Peugeot	Metropolis 3 wheels			
195/195EV	Honda	Integra 750 (from 2014)		*	

* Suggested compatibility. Confirm actual fitting with your mechanic.

** SGAS - Inflatable recommended compatibility

 Also available in EVO version

 Only available in EVO version

Product code index

010/020/050/ 065/075/085/ 080/090	Helmet Ears TM	p. 78	670	North Pole	p. 60	8914WF002	Serissa	p. 28
1100	El'met	pp. 80-82	670K	North Pole Kid	p. 46	8915WF023	Trudy	p. 32
1250	Long Visor	p. 80	671	South Pole	p. 60	8916WF024	Mercoledi	p. 32
1251	Goggle Shaped Visor	p. 80	671K	South Pole Kid	p. 46	8918MF029	Ermes	p. 16
1260	Cover V	p. 80	672	North Pole Lady	p. 60	8919WF029	Iris	p. 26
1261	Cover SV	p. 80	673	South Pole Lady	p. 60	8926MF031	Gins	p. 25
1270	Inner	p. 80	685	Sharpei	p. 67	8927MF031	K-Gins	p. 25
1272	Letters&Co.	p. 78	690	Lagotto W	p. 68	8935MF040	4Tempi	p. 18
216/218/220/222/224	Bike Covers	p. 77	695	Cappello Sharpei	p. 66	8936WF040	4Tempi Lady	p. 26
313	Shoe Protector	p. 77	696	Twist Again	p. 70	8937MF022	Park	p. 19
314	Foot On	p. 77	6678	Upload	p. 59	8938MF038	Carter	p. 21
315	Panama	p. 76	6679	Download	p. 59	8939MF039	2Cilindri	p. 21
317	Atollo	p. 76	6680	Upload Lady	p. 59	8942WF039	Candela	p. 27
319BOX	Papam	p. 76	6681	Download Lady	p. 59	8943MF57	Piumatico	p. 18
345BOX	Flowers	p. 78	710WB	WB Bib	p. 64	8944WF039	Bicilindrica	p. 29
439	Helmet Bag	p. 73	7171	Water Resistant Throat Collar	p. 64	8945WF53	Biella	p. 30
455	Small Off-Road Bag	p. 73	718	Nano Shoe Cover with Zip	p. 42	904DM	Monty Touch	p. 54
457	Big Off-Road Bag	p. 73	719WB	WB Neck Warmer	p. 65	906DU	Ginko Winter Touch	p. 50
462	Ninja Backpack	p. 72	721WB	WB Cover Knee	p. 65	970	Hector Diluvio	p. 52
463	Ninja Messenger	p. 71	730	Tuta Nano	p. 42	978DW	Mary Touch	p. 54
464	Ninja Leg Bag	p. 72	733	Panta Nano	p. 41	984	Urbano	p. 55
473	Waterproof Bag Small Size	p. 73	751	Gilet Nano Reflex	p. 41	991	Seppia Invernale	p. 51
474	Nano Duffle Bag	p. 74	760	Nano Rain Jacket	p. 39	999	Aviatore	p. 51
475	Nano Pochette	p. 74	760K	Nano Rain Jacket Kid	p. 45	9908	Softy Suede	p. 56
476	Nano Shopper Bag	p. 75	761	Nano Rain Lady Jacket	p. 39	9909	Softy Suede lady	p. 56
477	Nano Family Shopper Bag	p. 75	762	Nano Bullet	p. 40	9915U	Firewall	p. 49
478	Nano Backpack	p. 74	763	Nano Lady Bullet	p. 40	9917M	Flaming	p. 49
516	Parabellum	p. 34	809	CE Approved Back Protector	p. 85	9918U	Hub	p. 50
520E	Shoe Cover with Side Zip	p. 38	831T	Panta Urbis T	p. 24	9919U	Password	p. 55
524	Panta Diluvio Light	p. 36	832K	Urbanji Kid	p. 45	9925U	Road	p. 48
534	Diluvio Light Set	p. 35	870K	Montgomery Kid	p. 44	9926M	Softy Touch	p. 53
535	Diluvio Trousers	p. 37	898MF042	Pignone	p. 22	9927W	Softy Lady Touch	p. 53
536	Padded Diluvio Trousers	p. 37	899WF042	Freccia	p. 29	9928U	New Super Insulator	p. 52
537	Diluvio Jacket	p. 36	8000	Modulo Airbag AB	p. 83	9929U	Skinsulator	p. 52
560	Parabella	p. 34	8000A	Modulo Airbag AB Cool Pad + Pocket	p. 83	9930U	Gordon Nano	p. 57
561	Ponciarello	p. 38	8000R	Modulo Airbag AB Cannister + Threaded Refill Tool	p. 83	9931U	Tandem	p. 57
563	Noè Diluvio Set	p. 35	8002	D30 1 Elbow Armour	p. 84	9932U	Hot Road	p. 48
605	Cappuccetto	p. 69	8003	D30 2 Elbow Armour	p. 84	R091	Termoscud® Passenger	p. 12
606	Balokol	p. 69	8004	D30 1 Shoulder Armour	p. 84	R092	Termoscud® Passenger	p. 12
608	Telemark	p. 69	8005	D30 2 Shoulder Armour	p. 84	R093	Takeaway	p. 12
614	Collar Warmer Hat	p. 70	8006	D30 1 Back Armour for Pocket	p. 85	R333	Polyamide Hand Grip Cover	p. 13
615	Fleece Collar	p. 62	8007	D30 1 Knee Armour	p. 84	R333EV	Heated Polyamide Hand Grip Cover	p. 13
615AF	Fleece Collar	p. 62	8008	D30 1 Hip Armour	p. 85	R360	Neoprene Hand Grip Covers	p. 14
615WB	WB Fleece Collar	p. 62	8833K	WSP Kid	p. 44	R361	Neoprene Hand Grip Covers	p. 14
618WB	WB Jet Under-Helmet Silk 100%	p. 63	8855	Giacca Trip AB	p. 17	R365	Neoprene Hand Grip Covers	p. 14
621	Rain Resistant Under-Hel- met	p. 63	8888	Laura	p. 30	GAUCHO		p. 11
624	Cappello MAG	p. 69	8889	Low Dog	p. 22	TERMOSCUD®		pp. 8-10
625WB	WB Full Face Under-Helmet Silk 100%	p. 63	8890	Low Dan	p. 31	TERMOSCUD® EVO		pp. 6-7
626	Martin	p. 70	8891	Hot Fab	p. 23			
627	Francis	p. 70	8892	Hot Dan	p. 31			
642	Cintuca	p. 76	8906MF021	Benjamin	p. 20			
643	Smoggy	p. 76	8907MF021	Ficus	p. 20			
651	Brancaleone	p. 61	8908WF021	Brigitte Barbet	p. 28			
655	Capotte	p. 61	8909MF017	Mod	p. 19			
659	Galahad	p. 61	8910MF022	Urbis 4G	p. 17			
661	Merlino	p. 61	8911MF023	Rudy	p. 23			
669	Polo Gloves	p. 61	8912MF024	Gomez	p. 24			
			8913WF002	Modette	p. 27			



Tucano Urbano Srl
Via 2 Giugno 60/b5
20068 Peschiera Borromeo (MI)
tel +39.02.55305203
fax +39.02.55301411
export@tucanourbano.com

tucanourbano.com